

Smart choice for power

xantrex

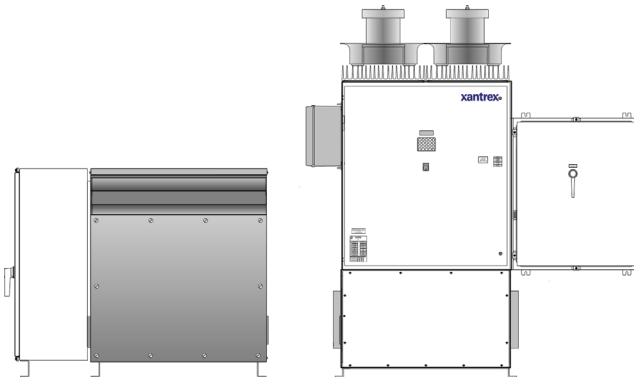

PV225S-480-P

Operation and Maintenance Manual

**PV225S 225 kW
Grid-Tied
Photovoltaic
Inverter**

www.xantrex.com

PV225S 225 kW Grid-Tied Photovoltaic Inverter

Operation and Maintenance Manual

About Xantrex

Xantrex Technology Inc. is a world-leading supplier of advanced power electronics and controls with products from 50 watt mobile units to one MW utility-scale systems for wind, solar, batteries, fuel cells, microturbines, and backup power applications in both grid-connected and stand-alone systems. Xantrex products include inverters, battery chargers, programmable power supplies, and variable speed drives that convert, supply, control, clean, and distribute electrical power.

Trademarks

PV225S 225 kW Grid-Tied Photovoltaic Inverter is a trademark of Xantrex International. Xantrex is a registered trademark of Xantrex International.

Other trademarks, registered trademarks, and product names are the property of their respective owners and are used herein for identification purposes only.

Notice of Copyright

PV225S 225 kW Grid-Tied Photovoltaic Inverter Operation and Maintenance Manual© August 2005 Xantrex International. All rights reserved.

Disclaimer

UNLESS SPECIFICALLY AGREED TO IN WRITING, XANTREX TECHNOLOGY INC. ("XANTREX")

(a) MAKES NO WARRANTY AS TO THE ACCURACY, SUFFICIENCY OR SUITABILITY OF ANY TECHNICAL OR OTHER INFORMATION PROVIDED IN ITS MANUALS OR OTHER DOCUMENTATION.

(b) ASSUMES NO RESPONSIBILITY OR LIABILITY FOR LOSS OR DAMAGE, WHETHER DIRECT, INDIRECT, CONSEQUENTIAL OR INCIDENTAL, WHICH MIGHT ARISE OUT OF THE USE OF SUCH INFORMATION. THE USE OF ANY SUCH INFORMATION WILL BE ENTIRELY AT THE USER'S RISK.

Date and Revision

August 2005 Revision B

Part Number

152607

Contact Information

Telephone: 1 800 670 0707 (toll free North America)
1 360 925 5097 (direct)

Fax: 1 800 994 7828 (toll free North America)
1 360 925 5143 (direct)

Email: customerservice@xantrex.com

Web: www.xantrex.com

About This Manual

Purpose

The purpose of this Operation and Maintenance Manual is to provide explanations and procedures for operating, maintaining, and troubleshooting the PV225S 225 kW Grid-Tied Photovoltaic Inverter. Installation instructions are available in the PV225S 225 kW Grid-tied Photovoltaic Inverter Planning and Installation Manual.

Scope

This Manual provides safety guidelines and information about operating and troubleshooting the unit.

Audience

This Manual is intended for anyone who needs to operate the PV225S 225 kW Grid-Tied Photovoltaic Inverter. Operators must be familiar with all the safety regulations pertaining to operating high-voltage equipment as dictated by local code. Operators must also have a complete understanding of this equipment's features and functions.

Organization

This Manual is organized into five chapters and one appendix.

Chapter 1, "Introduction" contains information about the features and functions of the PV225S 225 kW Grid-Tied Photovoltaic Inverter.

Chapter 2, "Operation" contains information on the basic operation of the PV225S 225 kW Grid-Tied Photovoltaic Inverter.

Chapter 3, "Commissioning" contains information on safely commissioning the PV225S 225 kW Grid-Tied Photovoltaic Inverter.

Chapter 4, "Troubleshooting" contains information and procedures for troubleshooting the PV225S 225 kW Grid-Tied Photovoltaic Inverter. It provides descriptions of common situations and errors that may occur and provides possible solutions for resolving fault conditions. It also provides instructions for clearing faults manually, if required.

Chapter 5, "Preventative Maintenance" contains information and procedures for performing preventative maintenance on the PV225S 225 kW Grid-Tied Photovoltaic Inverter.

Appendix A provides the environmental and electrical specifications for the PV225S 225 kW Grid-Tied Photovoltaic Inverter.

Conventions Used

The following conventions are used in this guide.



WARNING

Warnings identify conditions or practices that could result in personal injury or loss of life.



CAUTION

Cautions identify conditions or practices that could result in damage to the unit or other equipment.

Important: These notes describe things which are important for you to know, but not as serious as a caution or warning.

This Manual contains information for the PV225S-480-P 225 kW Grid-Tied Photovoltaic Inverter. Throughout the manual it will be referred to as the PV225S, unless otherwise noted.

Abbreviations and Acronyms

CCU2	Converter Control Unit 2
CFM	Cubic Feet per Minute
CW	Clockwise
DSP	Digital Signal Processor
FPGA	Field Programmable Gate Array
GUI	Graphical User Interface
IEEE	Institute of Electrical and Electronics Engineers
IGBT	Insulated Gate Bipolar Transistor
IPM	Intelligent Power Module
kcil	1000 circular mils
LAN	Local Area Network
POTS	Plain Old Telephone Service
PSL	Phase-Shift Loop
PV	Photovoltaic
UFCU	Universal Frontpanel Control Unit

Related Information

You can find more information about Xantrex Technology Inc. as well as its products and services at **www.xantrex.com**.

Important Safety Instructions

SAVE THESE INSTRUCTIONS - DO NOT DISCARD

This manual contains important safety instructions for the PV225S that must be followed during installation and maintenance procedures.



WARNING: Shock Hazard

Read and keep this Operation and Maintenance Manual for future reference. Before installing the PV225S, read all instructions, cautionary markings, and all other appropriate sections of this manual. Failure to adhere to these warnings could result in severe shock or possible death. Exercise extreme caution at all times to prevent accidents.



WARNING: Shock Hazard

The PV225S enclosures contain exposed high voltage conductors. The enclosure doors should remain closed with the latches tightened, except during maintenance or testing. These servicing instructions are for use by qualified personnel who meet all local and state code requirements for licensing and training for the installation of Electrical Power Systems with AC and DC voltage to 600 volts. To reduce the risk of electric shock, do not perform any servicing other than that specified in the installation instructions unless you are qualified to do so. Do not open the cabinet doors if extreme moisture is present (rain or heavy dew).



WARNING: Lethal Voltage

In order to remove all sources of voltage from the PV225S, the incoming power must be de-energized at the source. This may be done at the main utility circuit breaker and by opening the AC Disconnect and the DC Disconnect Switches on the PV225S. Review the system configuration to determine all of the possible sources of energy. In addition, allow 5 minutes for the DC bus capacitors, located on the ceiling of the cabinet, to discharge after removing power.

General Safety Precautions

1. When installing the PV225S use only components recommended or sold by Xantrex. Doing otherwise may result in a risk of fire, electric shock, injury to persons, and will void the warranty.
2. Do not attempt to operate the PV225S if it has been dropped, or received more than cosmetic damage during transport or shipping. If the PV225S is damaged, or suspected to be damaged, see the Warranty section of this manual.
3. To reduce the risk of electrical shock, lock-out and tag the PV225S before attempting any maintenance, service, or cleaning.

Personal Safety

Follow these instructions to ensure your safety while working with the PV225S.

Safety Equipment

Authorized service personnel must be equipped with standard safety equipment including the following:

- Safety glasses
- Ear protection
- Steel-toed safety boots
- Safety hard hats
- Padlocks and tags
- Appropriate meter to verify that the circuits are de-energized (600 Vac and DC rated, minimum)

Check local safety regulations for other requirements.

Wiring Requirements

1. All wiring methods and materials shall be in accordance with the National Electrical Code ANSI/NFPA 70. When sizing conductors and conduits interfacing to the PV225S, both shall be in accordance with the National Electric Code ANSI/NFPA 70, as well as all state and local code requirements.
2. Use copper conductors only with insulation rated for 90 °C.
3. The PV225S has a three-phase output. It is marked with this symbol: \emptyset
4. The AC power conductor wiring interfacing with the AC terminals in the Transformer Enclosure are located at T6-X1, T6-X2, and T6-X3. These terminals should be tightened to a torque value of 420 in-lb (47.5 Nm). Conductors terminated to these terminals must use a crimp-on type ring

- terminal or compression lug. The terminals can accommodate up to two conductors per phase. *See the PV225S 225 kW Grid-tied Photovoltaic Inverter Planning and Installation Manual for the location of these terminals.*
5. The AC power conductor wiring interfacing with the AC terminals in the Main Inverter Enclosure are located at TB5, TB6, and TB7. These terminals are to be tightened to a torque value of 375 in-lb (42.4 Nm). The terminals will accept a conductor size of 350 kcmil and can accommodate up to six conductors per phase. *See Figure 5-1 on page 5-4 for the location of these terminals.*
 6. The AC power conductor wiring interfacing with the AC terminals in the AC Interface Enclosure are located at S1-2T1, S1-4T2, and S1-6T3. These terminals should be tightened to a torque value of 310 in-lb (35.0 Nm). *See Figure 5-2 on page 5-4 for the location of these terminals. Also see the cautionary note in the PV225S 225 kW Grid-tied Photovoltaic Inverter Planning and Installation Manual regarding hardware length.*
 7. The AC neutral conductor from the utility is terminated in the AC Interface Enclosure at the TB11 terminal. This terminal requires the use of a crimp-on type ring terminal or compression-type lug and should be tightened to a torque value of 228 in-lb (25.7 Nm). *See Figure 5-2 on page 5-4 for the location of these terminals.*
 8. The DC power conductor wiring interfacing with the DC terminals at S2-6, K2-6T3, and TB4 are to be tightened to a torque value of 600 in-lbs (67.8 Nm). These terminals will accept a conductor size of 600 kcmil, and can accommodate up to four conductors per pole at S2-6 and K2-6T3 and up to two conductors at TB4. Keep these cables together as much as possible and ensure that both cables pass through the same knockout and conduit fittings, thus allowing any inductive currents to cancel. *See Figure 5-3 on page 5-5 for the location of these terminals.*
 9. This product is intended to be installed as part of a permanently grounded electrical system per the National Electric Code ANSI/NFPA 70. A copper ground rod must be installed within three feet of the PV225S enclosure. This is the single point earth ground for the inverter system. The single point ground for the system is to be made at the AC ground bus bar (TB12) in the AC Interface Enclosure. This terminal requires the use of a crimp-on type ring terminal or compression-type lug and should be tightened to a torque value of 420 in-lb (47.5 Nm).
 10. The equipment grounds on the PV225S is marked with this symbol: 
 11. AC overcurrent protection for the utility interconnect (Grid-tie) must be provided by the installers as part of the PV225S installation.



CAUTION: Fire Hazard

In accordance with the National Electrical Code, ANSI/NFPA 70, connect only to a circuit provided with 400 amperes maximum branch circuit overcurrent protection for the PV225S.

Operational Safety Procedures

Never work alone when servicing this equipment. A team of two is required until the equipment is properly de-energized, locked-out and tagged, and verified de-energized with a meter.

Thoroughly inspect the equipment prior to energizing. Verify that no tools or equipment have inadvertently been left behind.

Lockout and Tag

Safety requirements mandate that this equipment not be serviced while energized. Power sources for the PV225S must be locked-out and tagged prior to servicing. Each energy source should have a padlock and tag installed on each energy source prior to servicing.



WARNING: Shock Hazard

Review the system schematic for the installation to verify that all available energy sources are de-energized. DC bus voltage may also be present. Be sure to wait the full 5 minutes to allow the capacitors to discharge completely.

The PV225S can be energized from both the AC source and the DC source. To ensure that the inverter is de-energized prior to servicing, lockout and tag the PV225S using the following procedure.

1. Open, lockout, and tag the incoming power at the utility main circuit breaker.
2. Open, lockout, and tag the AC Disconnect Switch (S1) on AC interface assembly. See Figure 1-8 on page 1–12 for the location of the AC Disconnect Switch.
3. Open, lockout, and tag the DC Disconnect Switch (S2) on DC interface assembly. See Figure 1-8 on page 1–12 for the location of the DC Disconnect Switch.
4. Using a confirmed, accurate meter, verify all power to the inverter is de-energized. A confirmed, accurate meter must be verified on a known voltage before use. Ensure that all incoming energy sources are de-energized by checking the following locations.
 - a) *Inverter Terminals*: **TB5, TB6, TB7** (Phase A, B, C)
See Figure 5-1 on page 5–4.
 - b) *Utility Terminals*: **Top of S1-2T1, S1-4T2, S1-6T3**
See Figure 5-2 on page 5–4.
 - c) *PV Terminals*: **Bottom of S2-6, K2-6T3, TB4** (PV+, PV-, GND)
See Figure 5-3 on page 5–5.

De-Energize/Isolation Procedure

The following procedure should be followed to de-energize the PV225S for maintenance.



WARNING

The terminals of the DC input may be energized if the PV arrays are energized. In addition, allow 5 minutes for all capacitors within the main enclosure to discharge after disconnecting the PV225S from AC and DC sources.

To isolate the PV225S:

1. Turn the ON/OFF switch to the OFF position.
2. Open the DC Disconnect Switch.
3. Open the AC Disconnect Switch.
4. Open the utility connection circuit breaker.
5. Install lockout devices on the utility connection circuit breaker and DC Disconnect Switch.

Interconnection Standards Compliance

The PV225S has been tested and listed by Underwriters Laboratories to be in compliance with *UL 1741 Static Inverters And Charge Controllers For Use In Photovoltaic Power Systems*, as well as *IEEE-929-2000 Recommended Practice For Utility Interface of Photovoltaic (PV) Systems*.

IEEE-929-2000 provides guidance regarding equipment and functions necessary to ensure compatible operation of photovoltaic systems which are connected in parallel with the electric utility.

UL1741 is the standard applied by Underwriters Laboratory to the PV225S to verify it meets the recommendations of IEEE-929-2000.

Refer to both documents for details of these recommendations and test procedures.

Contents

Important Safety Instructions	vii
--	-----

1 Introduction

Operation Features	1-2
Fixed Unity Power Factor Operation	1-2
Peak Power Tracking	1-3
Dynamic DC Minimum Operating Voltage	1-4
Utility Voltage/Frequency Fault Automatic Reset	1-4
Safety Features	1-5
Anti-Island Protection	1-5
PV Ground Fault Detection	1-5
DC Over-voltage Detection	1-5
Physical Characteristics	1-6
Main Inverter Enclosure	1-7
Power Distribution Panel	1-7
Converter Control Unit (CCU2)	1-7
Power Electronics Matrices	1-7
Inductor Enclosure	1-7
DC Interface Enclosure	1-8
Transformer Enclosure	1-8
AC Interface Enclosure	1-8
Communications Enclosure	1-9
Operator Interface Controls	1-10
Main Enclosure Door Interlock Switch	1-10
On/Off Switch	1-11
AC and DC Disconnect Switches	1-12
Communication Features	1-12
System Status and Fault Reporting	1-13
Data Logging	1-13
Communication Methods	1-14
Universal Front Panel Control Unit (UFCU)	1-14
PC Connection Methods	1-15
POTS Access	1-16
Wireless Access	1-16
Ethernet LAN Access	1-17
Direct Access	1-17
GUI Software Features	1-18

2 Operation

Description of System Operation- - - - -	2-2
Overview - - - - -	2-2
Faults - - - - -	2-2
Operating States- - - - -	2-4
Power Tracking - - - - -	2-4
Transition - - - - -	2-4
Shutdown - - - - -	2-5
Fault - - - - -	2-5
Manual Current - - - - -	2-5
Matrix Test - - - - -	2-5
Automatic Sleep Test - - - - -	2-5
Operator Interface- - - - -	2-6
UFCU Keypad Operation and LCD Display - - - - -	2-6
LCD Display - Initialization Screen - - - - -	2-7
Standard Display - - - - -	2-7
Menu Structure - - - - -	2-8
Read Menu - - - - -	2-9
Write Menu - - - - -	2-15
Commanding Goal State Changes - - - - -	2-20
Setting the Date and Time - - - - -	2-21
Manual State Transitions - - - - -	2-22
Automatic State Transitions - - - - -	2-22
Auto-restart Feature - - - - -	2-23
Energize Procedure (Startup) - - - - -	2-24
Computer Communications with the PV225S - - - - -	2-25
Installing the Graphic User Interface (GUI) Software - - - - -	2-26
Minimum System Requirements - - - - -	2-26
Starting the Software Setup Program - - - - -	2-26
Starting the Setup Program Using Autorun - - - - -	2-26
Starting Setup Manually - - - - -	2-26
Starting Setup From a Command Prompt - - - - -	2-27
Model Specific Software Installation - - - - -	2-28
Running the GUI - - - - -	2-31
Remote/LAN Connection - - - - -	2-31
Direct Connection - - - - -	2-32
GUI Configuration - Adding Inverters - - - - -	2-33
GUI Help - - - - -	2-37

3 Commissioning

Commissioning Procedure ----- 3-2
Starting the Commissioning Test File ----- 3-2
 Serial Number ----- 3-3
 Verify AC Voltage ----- 3-3
 Verify DC Voltage ----- 3-3
 Inspect Inductor Enclosure ----- 3-4
 Apply Grid Voltage ----- 3-4
 Front Panel Display ----- 3-4
 Establish Communications with the GUI ----- 3-5
 Confirm AC Operational Parameters ----- 3-5
 Confirm DC Operational Parameters ----- 3-6
 Confirm Power Tracker Configuration Operational Parameters ----- 3-6
 Verify Door Interlock Functions ----- 3-6
 Matrix Test ----- 3-6
 Operate Inverter ----- 3-7
 Completed Commissioning ----- 3-7

4 Troubleshooting

Faults and Fault Codes ----- 4-2
General Troubleshooting ----- 4-2
Clearing Faults Manually ----- 4-3
Fault Code Descriptions ----- 4-4

5 Preventative Maintenance

Maintenance Safety ----- 5-2
 Operational Safety Procedures ----- 5-2
 De-Energize/Isolation Procedure ----- 5-2
 Lockout and Tag ----- 5-3
Periodic Maintenance ----- 5-6
 Monthly Intervals or As Required ----- 5-6
 Aluminum Extrusion Heatsinks ----- 5-6
 Fan Operation ----- 5-6
 Internal Circulation Fan ----- 5-6
 Inductor Enclosure Cooling Fans ----- 5-6
 Six-month Intervals ----- 5-7
 Enclosure Seals ----- 5-7
 Electrical Connections ----- 5-7
 Inductor Enclosure ----- 5-7

A Specifications

System Specifications ----- A-2
 Environmental Specifications ----- A-2
 Electrical Specifications ----- A-3
 Over Voltage, Under Voltage and Frequency Ranges ----- A-3
 Wire Gauge and Torque Requirements ----- A-4

Warranty and Product Information ----- WA-1

Index ----- IX-1

Figures

Figure 1-1	Maximum Peak Power Tracking	1-4
Figure 1-2	PV225S Major Components	1-6
Figure 1-3	DC Interface Enclosure	1-8
Figure 1-4	AC Interface Enclosure and Transformer Enclosure	1-9
Figure 1-5	PC Connections in the Communications Enclosure	1-9
Figure 1-6	PV225S Operator Interface Components	1-10
Figure 1-7	On/Off Switch (S3)	1-11
Figure 1-8	AC and DC Disconnect Switches	1-12
Figure 1-9	LCD Display and UFCU Location	1-14
Figure 1-10	PC Connections in the Communications Enclosure	1-15
Figure 1-11	POTS Access	1-16
Figure 1-12	Wireless Access	1-16
Figure 1-13	LAN Access	1-17
Figure 1-14	Direct Access	1-17
Figure 2-1	Operating States Flow Chart	2-3
Figure 2-2	The Universal Front Panel Control Unit (UFCU) and LCD	2-6
Figure 2-3	Initialization Screens	2-7
Figure 2-4	Operator Interface Menu Diagram	2-8
Figure 2-5	Scrolling through the Read Menu	2-10
Figure 2-6	Read-by-ID Feature	2-13
Figure 2-7	State Transition Diagram	2-20
Figure 2-8	LCD showing Fault Code	2-23
Figure 2-9	GUI Interface Main Menu Screen	2-25
Figure 2-10	Starting Setup from a Command Prompt	2-27
Figure 2-11	GUI Splash Screen	2-28
Figure 2-12	GUI Setup Welcome Window	2-28
Figure 2-13	GUI Setup Start Window	2-29
Figure 2-14	GUI Setup Program Group Window	2-29
Figure 2-15	GUI Setup Progress Indicator Window	2-30
Figure 2-16	GUI Setup Start Window	2-30
Figure 2-17	GUI Interface Screen if Connected Remotely	2-31
Figure 2-18	GUI Interface Screen if Connected Directly	2-32
Figure 2-19	Detail Screen	2-33
Figure 2-20	Contact Screen	2-33
Figure 2-21	Operational Configuration Screen - Limits	2-34
Figure 2-22	Operational Configuration Screen - PV	2-34
Figure 2-23	Operational Configuration Screen - Power Tracker	2-35

Figures

Figure 2-24	Connection Configuration Screen - General	-2-35
Figure 2-25	Connection Configuration Screen - Telephone Fault Configuration	-2-36
Figure 2-26	Connection Configuration Screen - General	-2-36
Figure 2-27	GUI Interface Screen if Connected Directly	-2-37
Figure 4-1	LCD showing Fault Code	4-3
Figure 5-1	Inverter AC Terminal Locations in the Main Inverter Enclosure	5-4
Figure 5-2	Utility AC Terminal Connections in the AC Interface Enclosure	5-4
Figure 5-3	PV Terminal Locations	5-5
Figure A-1	Electrical Diagram (sample)-	A-5
Figure A-2	PV225S Schematic for Main Power Distribution (152812 A1)	A-6
Figure A-3	PV225S Schematic for Control Power Distribution (152812 A2)	A-7
Figure A-4	PV225S Schematic for Converter Control Unit (152812 A3)-	A-8

Tables

Table 2-1	Scrolling through the Read Menu Parameters	2-9
Table 2-2	Read Menu Descriptions	2-11
Table 2-3	Data Logging Menu	2-14
Table 2-4	Accumulated Values Menu	2-14
Table 2-5	Write Menu Parameters	2-16
Table 4-1	Fault Codes	4-4
Table A-1	Environmental Specifications	A-2
Table A-2	Electrical Specifications	A-3
Table A-3	Over/Under Voltage and Over/Under Frequency Ranges	A-3
Table A-4	AC Terminal Wire Gauge, Bolt Size, and Torque Values	A-4
Table A-5	DC Terminal Wire Gauge, Bolt Size, and Torque Values	A-4

1

Introduction

Chapter 1, “Introduction” contains information about the features and functions of the PV225S 225 kW Grid-Tied Photovoltaic Inverter.

Operation Features

The PV225S 225 kW Grid-Tied Photovoltaic Inverter is a UL 1741 listed, utility interactive, three-phase power conversion system for grid-connected photovoltaic arrays with a power rating of 225 kW. Designed to be easy to install and operate, the PV225S automates start-up, shutdown, and fault detection scenarios. With user-definable power tracking that matches the inverter to the array and adjustable delay periods, users are able to customize startup and shutdown sequences. Multiple PV225S inverters are easily paralleled for larger power installations.

The PV225S power conversion system consists of a pulse-width modulated (PWM) inverter, switch gear for isolation and protection of the connected AC and DC power sources, and a high efficiency custom Wye:Wye isolation transformer. Housed in a rugged NEMA-3R rated, powder-coated steel enclosure, the PV225S incorporates sophisticated Intellimod[®] (IPM) Insulated Gate Bipolar Transistors (IGBT's) as the main power switching devices. An advanced, field-proven, Maximum Peak Power Tracker (MPPT) integrated within the PV225S control firmware ensures the optimum power throughput for harvesting energy from the photovoltaic array.

The advanced design of the PV225S includes an EMI output filter and the main AC contactor located electrically on the utility side of the isolation transformer. The location of the main AC contactor, and the ability to de-energize the isolation transformer during times of non-operation, greatly reduces the night-time tare losses consumed by an idle isolation transformer. An integrated soft-start circuit precludes nuisance utility-tie circuit breaker trips as the result of isolation transformer inrush current.

Additionally, the PV225S integrated controller contains self-protection features including over and under voltage and frequency safeguards. An integral anti-island protection scheme prevents the inverter from feeding power to the grid in the event of a utility outage.

The PV225S includes a local user interface comprised of an ON/OFF switch, keypad, and 4-line, 80 character LCD display. A user-friendly Graphic User Interface (GUI) provides a remote interface for operator interrogation of PV225S system status, control, metering/data logging and protective functions within the PV225S. The status, control, and logging features are also supported by the choice of three communication mediums, allowing the information to be accessed or commanded remotely.

Fixed Unity Power Factor Operation

The Xantrex PV Series of grid-tied inverters maintains unity power factor during operation. The control software constantly senses utility voltage, and constructs the output current waveform to match the utility voltage. The PV line of inverters is not capable of operation without the presence of normal utility voltage, nor is it capable of varying the output power factor off unity.

Peak Power Tracking

An advanced, field-proven, Maximum Peak Power Tracker (MPPT) algorithm integrated within the PV225S control software ensures the optimum power throughput for harvesting energy from the photovoltaic array. The peak power voltage point of a PV array can vary, primarily depending upon solar irradiance and surface temperature of the PV panels. This peak power voltage point is somewhat volatile, and can easily move along the I-V curve of the PV array every few seconds. The MPPT algorithm allows the PV225S to constantly seek the optimum voltage and current operating points of the PV array, and maintain the maximum peak PV output power.

Accessible via the UFCU, there are five user settable parameters that control the behavior of the maximum peak power tracker within the PV225S. As show in Figure 1-1 on page 1–4, user settable parameters include:

- PPT V Ref (ID# 37),
- I PPT Max (ID#42),
- PPT Enable (ID# 44),
- PPT Rate (ID# 45), and
- PPT V Step (ID# 46).

Upon entering the Power Tracking mode, it takes approximately 20 seconds for the PV225S to ramp the PV voltage to the “PPT V Ref” setpoint regardless of the actual PV voltage.

With the “PPT Enable” set to “0” (power tracker disabled), the PV225S will regulate the DC Bus at the “PPT V Ref” setpoint. Regulating the DC bus means drawing more or less current out of the PV array to maintain this desired voltage.

With the “PPT Enable” set to “1” (power tracker enabled), followed by the expiration of the “PPT Rate” (MPPT decision frequency), the MPPT will reduce the reference voltage by an amount equal to the “PPT V Step” value.

At this point the MPPT will compare the amount of AC output power produced to the previous amount of AC power produced by the PV225S. If the output power has increased, the next change made (after “PPT Rate” has again expired) to the reference voltage, will be in the same direction.

Conversely, if the power comparison proves undesirable, the power tracker will reverse the direction of the change to the “PPT_V Step”. The MPPT algorithm within the PV225S will then continue this ongoing process of “stepping and comparing” in order to seek the maximum power throughput from the PV array.

The changes made by the MPPT to the reference voltage are restricted to $\pm 20\%$ of “PPT V Ref” and by the maximum and minimum PV input voltage (600 and 300 volts respectively). Also, the MPPT will not attempt to produce power greater than that allowed by the “I PPT Max” setpoint. If available PV power is above the maximum allowable power level of the PV225S, the MPPT will increase voltage as needed to maintain output power below rated maximum.

Optimization of the PV225S MPPT will result in an increase in energy production. The user is encouraged to study the PV array's I-V curves and to adjust the MPPT user settable parameters accordingly.

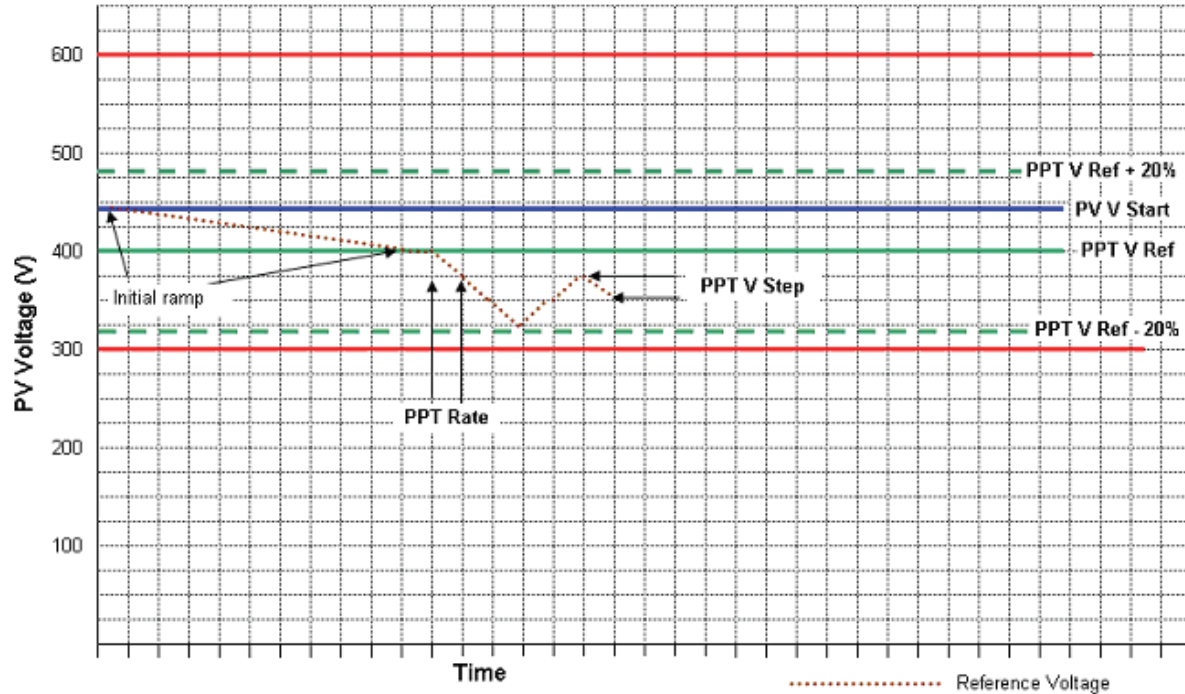

Figure 1-1 Maximum Peak Power Tracking

Dynamic DC Minimum Operating Voltage

The PV225S employs a unique approach to the minimum DC input voltage for operation. The CCU2 constantly monitors and calculates an average of the AC utility input voltage, thereby adjusting the required minimum DC input voltage threshold to optimize the sinusoidal AC output current waveform. Given a nominal input voltage of 208 Vac, the minimum DC input voltage threshold is 300 Vdc. On a transient basis, the PV225S does have the ability to adjust the minimum DC input voltage threshold to less than 300 Vdc.

Utility Voltage/Frequency Fault Automatic Reset

In the event of a utility voltage or frequency excursion outside of preset limits, the PV225S will stop operation and display a fault at the operator interface. Once the utility voltage has stabilized within acceptable limits for a period of at least 5 minutes, the PV225S will automatically clear the fault and resume normal operation. Voltage and frequency fault setpoints are detailed later in this section.

Safety Features

Anti-Island Protection

A condition referred to as "Islanding" occurs when a distributed generation source (such as the PV225S Grid-tied Photovoltaic Inverter) continues to energize a portion of the utility grid after the utility experiences an interruption in service. This type of condition may compromise personnel safety, restoration of service, and equipment reliability.

The PV225S employs a method for detecting the islanding condition using a Phase-Shift-Loop (PSL). This method is implemented in the CCU2 to prevent islanding of the PV225S. The CCU2 continuously makes minor adjustments to the power factor phase angle above and below unity. In the event of a utility interruption or outage, these adjustments destabilize the feedback between the inverter and the remaining load, resulting in an over/under frequency or voltage condition.

Upon detection of such a condition, the PV225S then performs an immediate orderly shutdown and opens both the main AC and DC contactors. The fault condition will remain latched until the utility voltage and frequency have returned to normal for at least 5 minutes.

This method has been extensively tested and proven to exceed the requirements of IEEE-929 (Recommended Practices for Utility Interface of Photovoltaic [PV] Systems) and UL-1741 (Static Inverters and Converters for use in Independent Power Systems).

PV Ground Fault Detection

The PV225S is equipped with a ground fault detection circuit by means of a Hall-effect current transducer (CT8). This circuit is active when the PV array is properly grounded. In the event of a ground fault exceeding 10 amps DC, the PV225S will execute an immediate orderly shutdown, open both the main AC and DC contactors, and report a ground fault on the LCD of the UFCU. The PV225S will remain faulted until the ground fault is remedied and the advisory is cleared at the operator interface.

For additional information, see Chapter 4, "Troubleshooting".

DC Over-voltage Detection

In the event of DC voltage greater than 600 Vdc, the PV225S will execute an orderly shutdown and will report a fault to the operator interface. If DC voltage remains greater than 600 Vdc, the PV225S may be irreparably damaged.

See Chapter 4, "Troubleshooting" for further information on this fault condition.

Physical Characteristics

The PV225S comes in two modules comprised of six enclosures to house the electronics described above. The first module includes the Main Inverter Enclosure, Inductor Enclosure, DC Interface Enclosure, and Communications Enclosure. The second module includes the Transformer Enclosure and AC Interface Enclosure.

These components are identified in Figure 1-2.

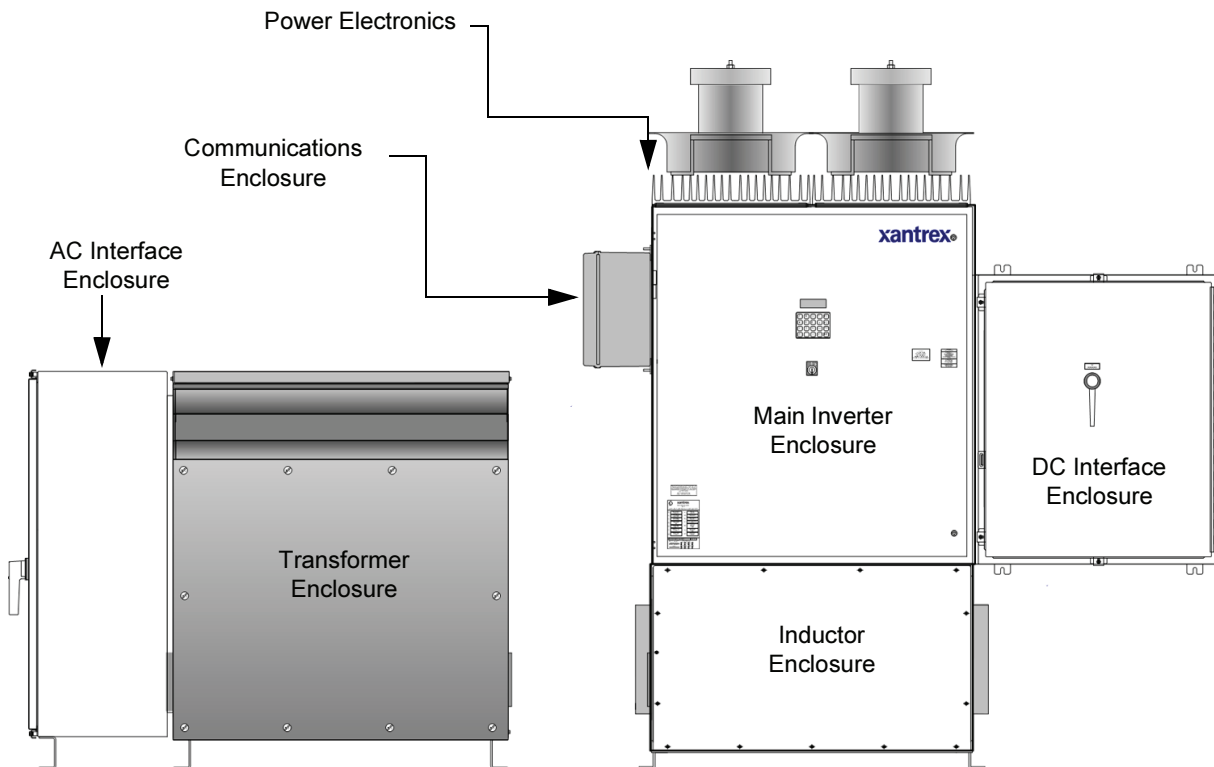

Figure 1-2 PV225S Major Components

Main Inverter Enclosure

The PV225S Main Inverter Enclosure is NEMA-3R rated and contains the power distribution panel, the converter control unit (CCU2), and the power electronics matrices. Also found within the Main Inverter Enclosure are some of the system protection devices (such as the sense and control power fuses).

Power Distribution Panel

This panel contains many of the Electromechanical, protective, and control power components necessary to support the operation of the PV225S.

Converter Control Unit (CCU2)

The CCU2 is a Digital Signal Processor (DSP) based control board that performs numerous control and diagnostic functions associated with PV225S operation. Its most significant tasks are control of PV225S electromechanical components and power electronics converters, signal conditioning for high voltage signal inputs and communication with the Universal Front Panel Control Unit, and system sensors. The CCU2 also contains the necessary DC power supplies to support its operation.

Power Electronics Matrices

The power electronics converters are located at the top of the PV225S main inverter enclosure. Both the left and right matrices are comprised of six switching transistors (IGBTs), transistor gate drive electronics, a laminated power bus, DC capacitor bank, and an aluminum extrusion heatsink with a cooling fan. The fans are located above each matrix heatsink.

The PV array is tied logically to the matrices DC bus within the DC interface enclosure. The embedded CCU2 control unit manages the transfer of power between the DC bus and the utility grid by sending digitized gating signals to the IGBTs for producing a high-fidelity, sinusoidal output.

Inductor Enclosure

The Inductor Enclosure is NEMA-3R rated. It contains the necessary filter components to ensure the PV225S line current meets IEEE-519 (1992, Standard Practices and Requirements for Harmonic Control in Electrical Power Systems) and UL 1741 (2001, Static Inverters and Converters for use in Independent Power Systems) harmonic distortion requirements. Mounted on both the right and left side of the lower enclosure are inductor fans to allow cooling of the line filter components within. This enclosure also serves as the mounting base for the PV225S Main Enclosure.

DC Interface Enclosure

The DC Interface Enclosure is NEMA-3R rated. The DC interface serves as the connection interface between the PV array and the PV225S. This enclosure is where the DC Disconnect Switch and DC contactor reside.



CAUTION: Equipment Damage

The fuses within the PV225S are intended for protecting the PV225S control circuitry only. They are not intended to provide protection for the PV array or external cabling.

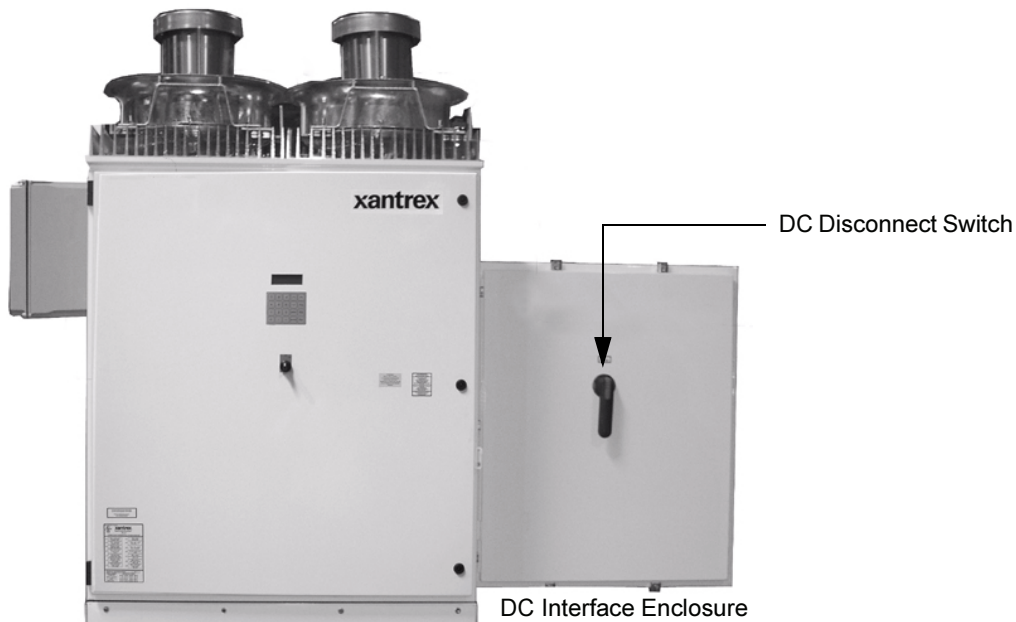

Figure 1-3 DC Interface Enclosure

Transformer Enclosure

The Transformer Enclosure is NEMA-3R rated. The main isolation transformer inside electrically isolates the PV225S from the utility power. Voltage-sensing circuit wiring and soft-start circuit pass through the Transformer Enclosure from the AC Interface Enclosure to the Main Inverter Enclosure.

AC Interface Enclosure

The AC Interface Enclosure is NEMA-3R rated. The AC interface serves as the connection between the utility and the isolation transformer. This enclosure is where the AC line fuses and AC Disconnect Switch reside. Also included in the AC Interface Enclosure are the main AC contactor and transformer soft-start circuit.

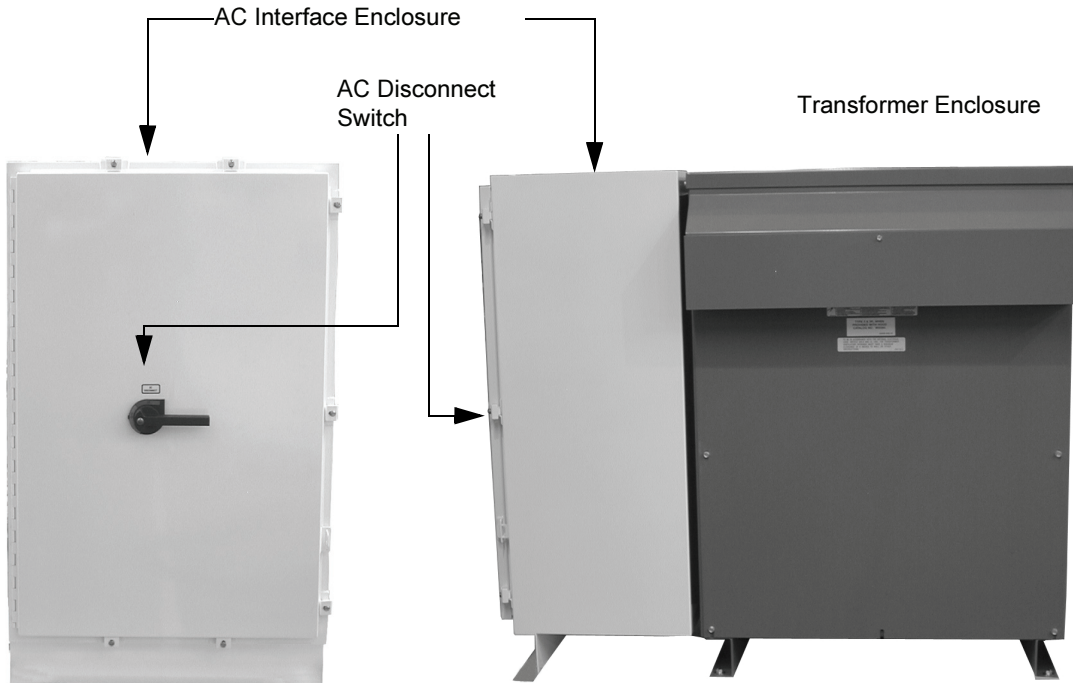

Figure 1-4 AC Interface Enclosure and Transformer Enclosure

Communications Enclosure

The Communications Enclosure is NEMA-4 rated. It contains the hardware to enable a personal computer to connect to the unit, either directly or remotely. Hardware could include a POTS Connect Kit, a Wireless Connect Kit, or an Ethernet LAN kit, or a Direct Connect Kit.

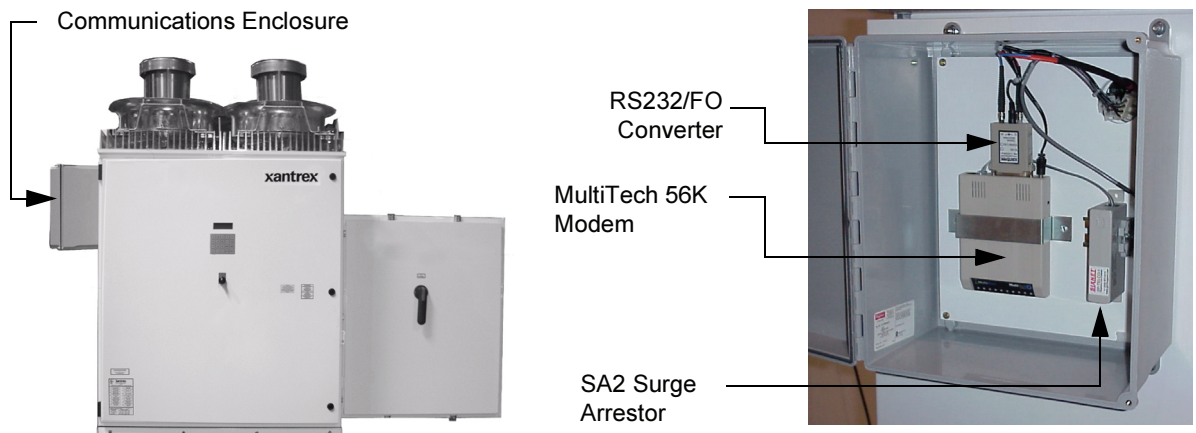

Figure 1-5 PC Connections in the Communications Enclosure

Operator Interface Controls

Operator interface controls are located on the front door of the main inverter enclosure. These controls include an ON/OFF Switch, 4-line LCD display and keypad called the Universal Frontpanel Control Unit (UFCU). Additionally there is an AC and DC Disconnect on the AC Interface Enclosure and the DC Interface Enclosure Doors.

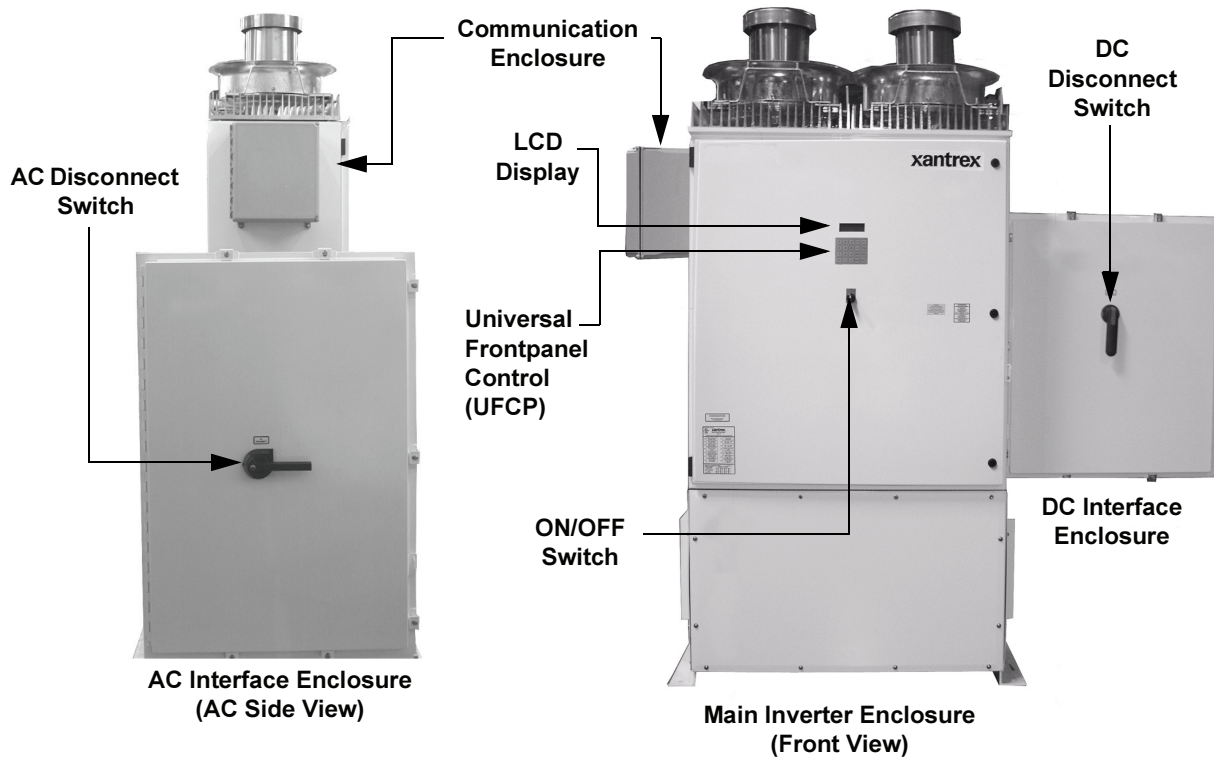

Figure 1-6 PV225S Operator Interface Components

Main Enclosure Door Interlock Switch

The front door of the PV225S main enclosure is equipped with an interlock switch to preclude operation while the front door is open. Opening the door of the main inverter enclosure will initiate an immediate controlled shutdown of the PV225S and opens both the main AC and DC contactors. The main AC and DC contactors cannot be closed unless the door's interlock is in the engaged position. The PV225S is prevented from being restarted until the door is again closed and the switch is in the engaged position.

It is required that the PV225S main enclosure door must be locked during normal operation. The door interlock switch does NOT remove all hazardous voltages from inside the inverter. Before attempting to service the PV225S, follow the de-energize Lockout and Tag procedure on page 5-3.

**WARNING: Shock Hazard**

Disengaging the main enclosure door interlock switch does NOT remove all hazardous voltages from inside the inverter. Before attempting to service the PV225S, follow the de-energize Lockout and Tag procedure on page 5-3.

On/Off Switch

The PV225S incorporates a maintained position ON/OFF Switch (S3) located on the front door of the main enclosure. Under normal conditions, the ON/OFF switch is in the ON position. Turning the switch to the OFF position will initiate an immediate controlled shutdown of the PV225S and open both the main AC and DC contactors within the unit. The main AC and DC contactors cannot be closed unless the switch is in the ON position. The PV225S is prevented from being restarted until the ON/OFF switch is turned back to the ON position.

**WARNING: Shock Hazard**

Turning the ON/OFF switch to the OFF position does NOT remove all hazardous voltages from inside the inverter. Before attempting to service the PV225S, follow the de-energize Lockout and Tag procedure on page 5-3.

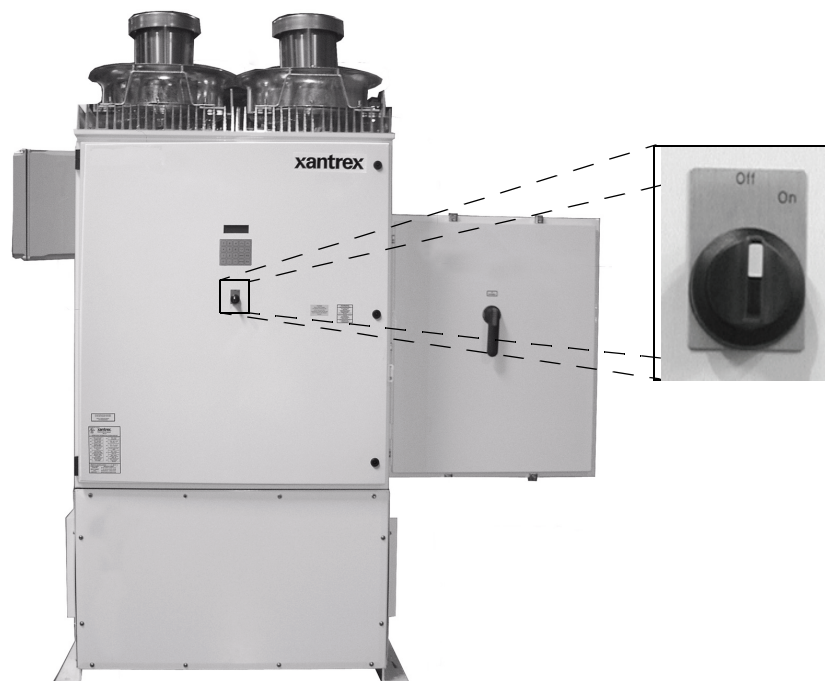

Figure 1-7 ON/OFF Switch (S3)

AC and DC Disconnect Switches

Both AC and DC interface enclosures are equipped with lockout hasps for personnel safety. The enclosure doors should not be opened while the PV225S is operating.

The switch handles and shafts provide a door interlock for both the AC and DC interface enclosures. The doors cannot be opened when the switch is in the ON position.

The DC Disconnect Switch (S2) is equipped with an auxiliary contact block which enables the switch to be used as a load break DC disconnect. In the event the DC Disconnect Switch is opened while the PV225S is processing power from the PV array, the early-break contact block will signal the CCU2 (Converter Control Unit 2) to stop processing power prior to opening the DC Disconnect Switch.

Additionally, opening the DC Disconnect Switch will cause the PV225S to execute an immediate orderly shutdown, open both the main AC and DC contactors, and report a PV disconnect fault on the LCD of the UFCU.

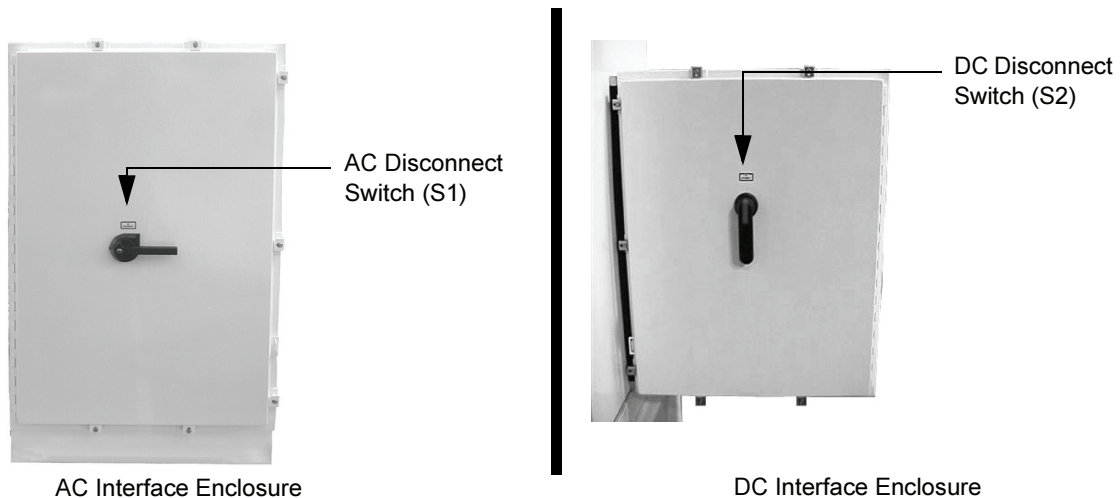

Figure 1-8 AC and DC Disconnect Switches

Communication Features

The PV225S provides two types of information to the user:

- system status and/or fault information, and
- data logging information.

System status and fault information can be accessed using the Universal Front Panel Control Unit (UFCU) or a personal computer (PC) using the Xantrex Solar Graphic User Interface (GUI) software. Data logging requires the use of a PC using the GUI software.

System Status and Fault Reporting

Basic system status and all fault conditions rising from within the PV225S are reported to the UFCU. The unit stores the time and details of all faults in non-volatile memory. The 4-line LCD will display a hexadecimal value and a brief text description of the fault.

This information can also be accessed using a personal computer using the GUI software either directly or remotely.

Types of status information include:

- Current Operating State or Goal State
- Fault Code (if applicable)
- Inverter State
- Line Voltage and Current
- Inverter Matrix Temperature
- Inverter Power
- PV State
- PV Voltage and Current
- PV Power
- Grid Frequency
- Peak Power Tracker Enabled

Data Logging

The inverter stores data values and software metrics for debugging. These values are stored within the CCU2 controller board in non-volatile memory. Data logging requires the use of a PC connection using the Xantrex Solar Graphic User Interface (GUI) software.

The Data logging features include:

- Operational Values
- Internal Metrics
- Data Log Acquisition
- Graphic Data Analysis
- Fault Log Acquisition
- Accumulated Values
- Configurable Parameters

For details on using this feature, consult the GUI Help program.

Communication Methods

The PV225S communicates system status information to the user using the following methods.

- The Front Panel Control Unit (UFCU) Display
- PC Connection (Direct or Remote) - Xantrex Solar Graphic User Interface (GUI) Software required. Communication with a PC requires the selection of one of the following options.
 - Remote Connection -- This method has three options available. One of these options will be field-installed prior to commissioning.
 - POTS Connection
 - Wireless Connection
 - Ethernet LAN Connection
 - Direct Connection -- This method is most commonly used by field technicians for commissioning and troubleshooting purposes.

Important: The customer is responsible for providing the appropriate support service to support a PC connection. (i.e., making arrangements for an analog phone line, data line, wireless service or local area network.)

Universal Front Panel Control Unit (UFCU)

The UFCU keypad is located on the front of the Main Inverter Enclosure to manipulate and view system operation and status.

The keypad is comprised of 20 touch-sensitive keys that provide a means to navigate through the menus and alter user-changeable settings.

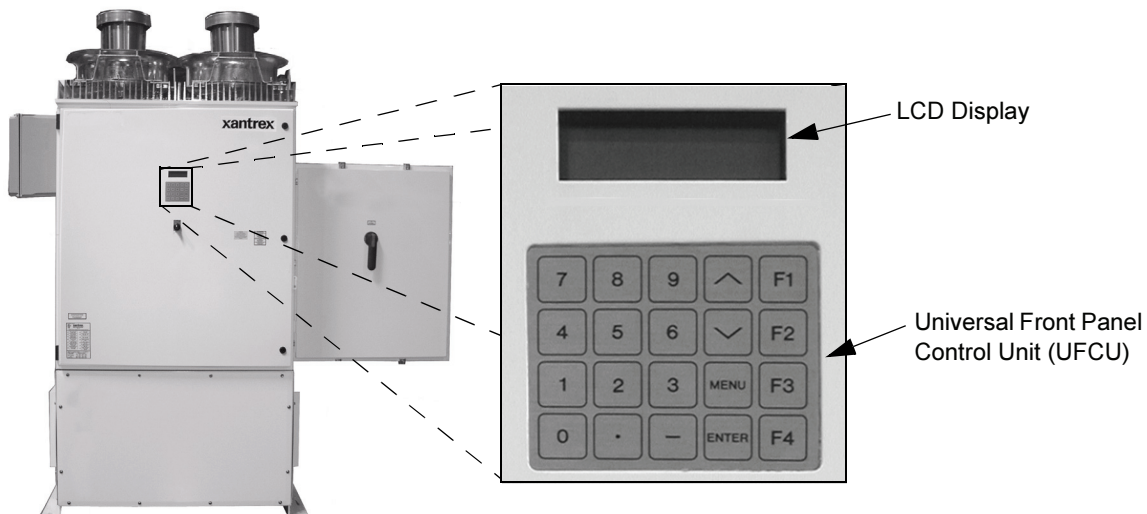

Figure 1-9 LCD Display and UFCU Location

See “UFCU Keypad Operation and LCD Display” on page 2–6 for details.

PC Connection Methods

Personal computers can be used to access the system status and programming features of the PV225S. A computer can be connected either directly or remotely.

1. Remote Connect - uses one of the three kits below.
 - POTS Kit - uses a MultiTech® 56K Modem, RS232/Fiber Optic Converter (configured for ethernet) and SA2 Surge Arrestor.
 - Wireless Kit - uses a GSM Wireless Modem.
 - Ethernet LAN Kit - uses a data communication device to enable the unit to connect to a local area network.
2. Direct Connect - This method is used for troubleshooting. It uses a RS232/Fiber Optic Converter (configured for a PC), a DB25-to-DB25 gender changer, and a DB25-to-DB9 Serial Cable.

Software is included to provide a graphic user interface that relates important system information. This software is called Xantrex Solar Graphic Interface (GUI). See “Minimum System Requirements” on page 2–26 for minimum system requirements.

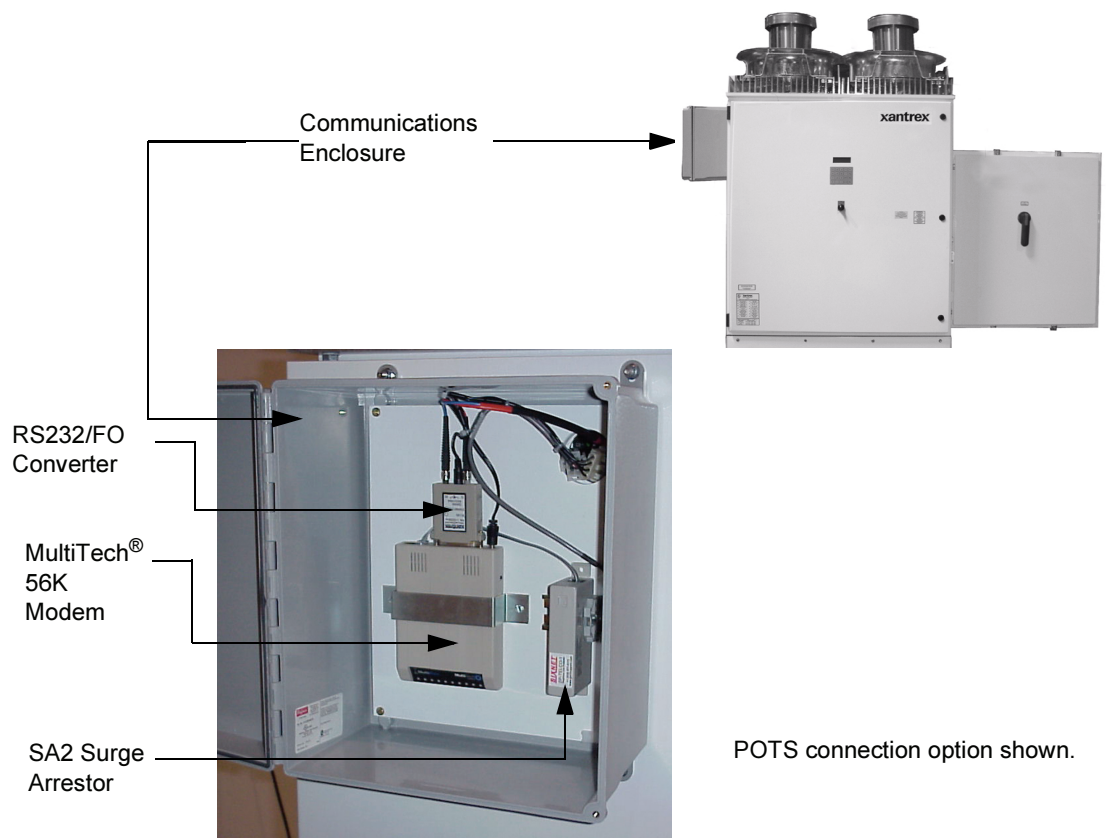

Figure 1-10 PC Connections in the Communications Enclosure

POTS Access

Figure 1-11 illustrates the PV225S connected remotely to a personal computer.

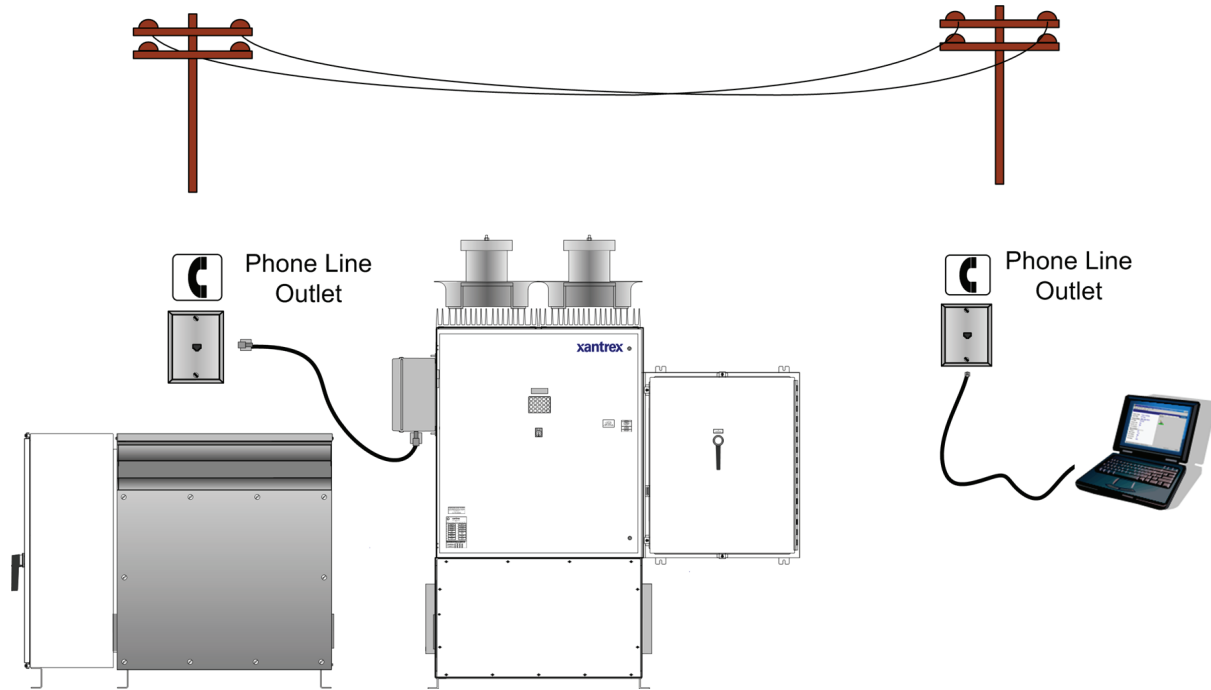

Figure 1-11 POTS Access

Wireless Access

Figure 1-12 illustrates the PV225S connected remotely to a personal computer using a wireless network.

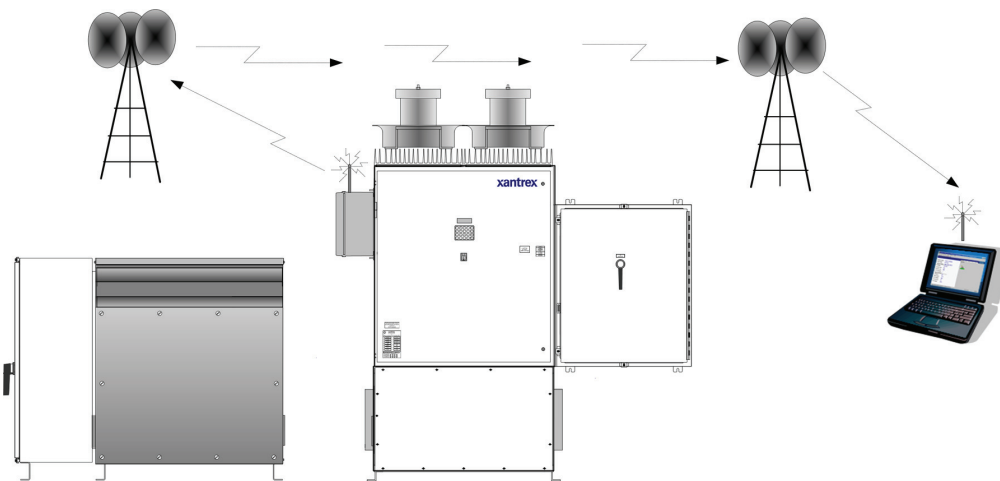

Figure 1-12 Wireless Access

Ethernet LAN Access

The PV225S can be remotely accessed through a local area network.

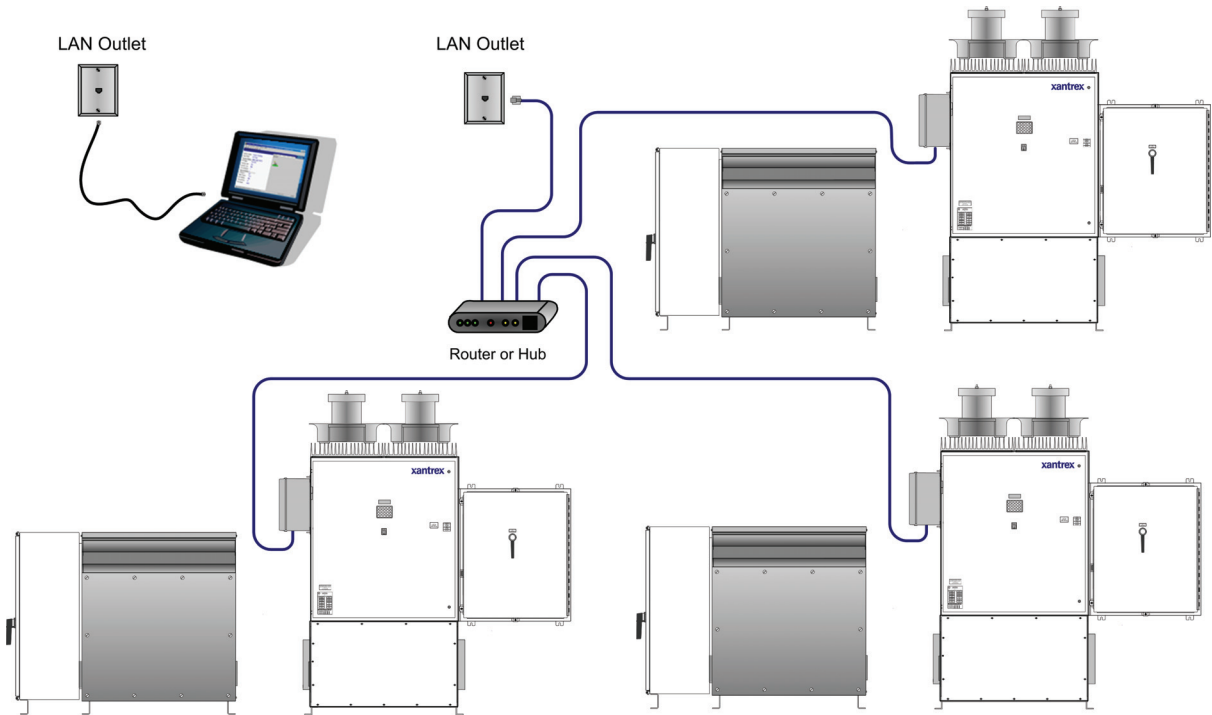

Figure 1-13 LAN Access

Direct Access

Figure 1-14 illustrates the PV225S connected directly to a personal computer.

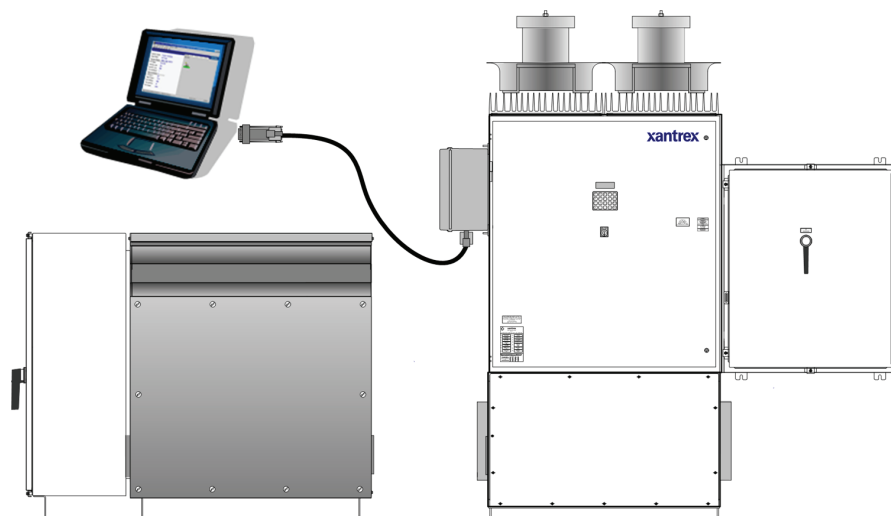

Figure 1-14 Direct Access

GUI Software Features

- Read-only Menu** The GUI software provides access to the following “Read-only Menu” information. *See Table 2-2, “Read Menu Descriptions” on page 2-11 for a specific list of available parameters.*
- Operational Values
 - Internal Metrics
- Write-Menu** The GUI software provides control of the following system parameters. These parameters are in the Write Menu.
- User-Configurable Parameters. *See Table 2-5, “Write Menu Parameters” on page 2-16 for a specific list of available parameters.*
- Data Logging** The GUI software provides the following data collection/reports (data logging). These features are not available through the Universal Front Panel Control Unit (UFCU).
- Operational Values - The present operational values (such as PV voltage and current, grid network voltage and frequency, or inverter current and power) can be read remotely.
 - Internal Metrics - The inverter also maintains internal software metrics for remote review by Xantrex field service or engineering.
 - Data Log Acquisition - The inverter maintains a data log in non-volatile memory for up to 30 days, after which the oldest data is overwritten. The GUI reads this data and updates a local file that can be imported to a spreadsheet.
 - Graphic Data Analysis - Local data log files generated by the GUI can be imported to a spreadsheet application, thus giving the ability to create a graphical chart for display and analysis.
 - Fault Log Acquisition - The inverter maintains a log of faults (description, time and date). This can be viewed remotely. The fault log is stored in the inverter’s non-volatile memory, and is also read by the GUI and stored at its computer in a text file.
 - Accumulated Values - The inverter tracks power production statistics, such as total energy sold, operating hours, power production hours, peak power and energy, energy by month, and energy by the hour. Accumulated values are stored in the inverter’s non-volatile memory, and are also read by the GUI and stored at its computer in a text file.
 - Configurable Parameters - The configuration parameters controlling the inverter’s operation can be viewed and changed from a remote GUI.
- See Table 2-3 on page 2-14 for a list of the Data Logging parameters available.

2

Operation

Chapter 2, “Operation” contains information on the basic operation of the PV225S 225 kW Grid-Tied Photovoltaic Inverter.

Description of System Operation

Overview

The PV225S is a fully automated grid-interactive photovoltaic inverter. System startup, system shutdown, PV power tracking, and fault detection scenarios are all governed and monitored by the CCU2 controller within the PV225S. Manual interaction or control of the inverter is necessary only in the event of a system fault. Additionally, the following conditions govern operation of the PV225S.

- Stable utility AC voltage and frequency as specified in Table A-3 must be present for all states of operation.
- PV voltage as specified in Table A-3 must be present.
- With the exception of the Matrix Test state, the ON/OFF switch, located on the front door of the PV225S main inverter enclosure, must be switched to the ON position for all operating states.
- The door of the main inverter enclosure must be closed with the door interlock switch in the engaged position.
- Both the AC and DC Disconnect switches must be in the ON or closed position.
- Fault conditions must not be present.

Faults

Fault states are automatic from any state of operation. In the event of a fault condition, the PV225S will immediately stop processing power and execute an immediate orderly shutdown, open both the main AC and DC contactors, and remain in a faulted state until the fault is remedied and cleared (manually or automatically).

Most faults are latching, and only those faults associated with grid disturbances are auto-clearing and thus enable the PV225S to restart after a 5 minute delay period. All fault conditions arising from within the PV225S are reported to the UFCU (Universal Frontpanel Control Unit). The 4-line LCD on the UFCU will display a hexadecimal value (fault code) and a brief text description of the fault.

Once the cause of the fault has been identified and corrected, and it is determined to be safe to proceed, PV225S faults may be cleared from the UFCU keypad or via the remote GUI.

See “Clearing Faults Manually” on page 4–3 for instructions on this procedure.

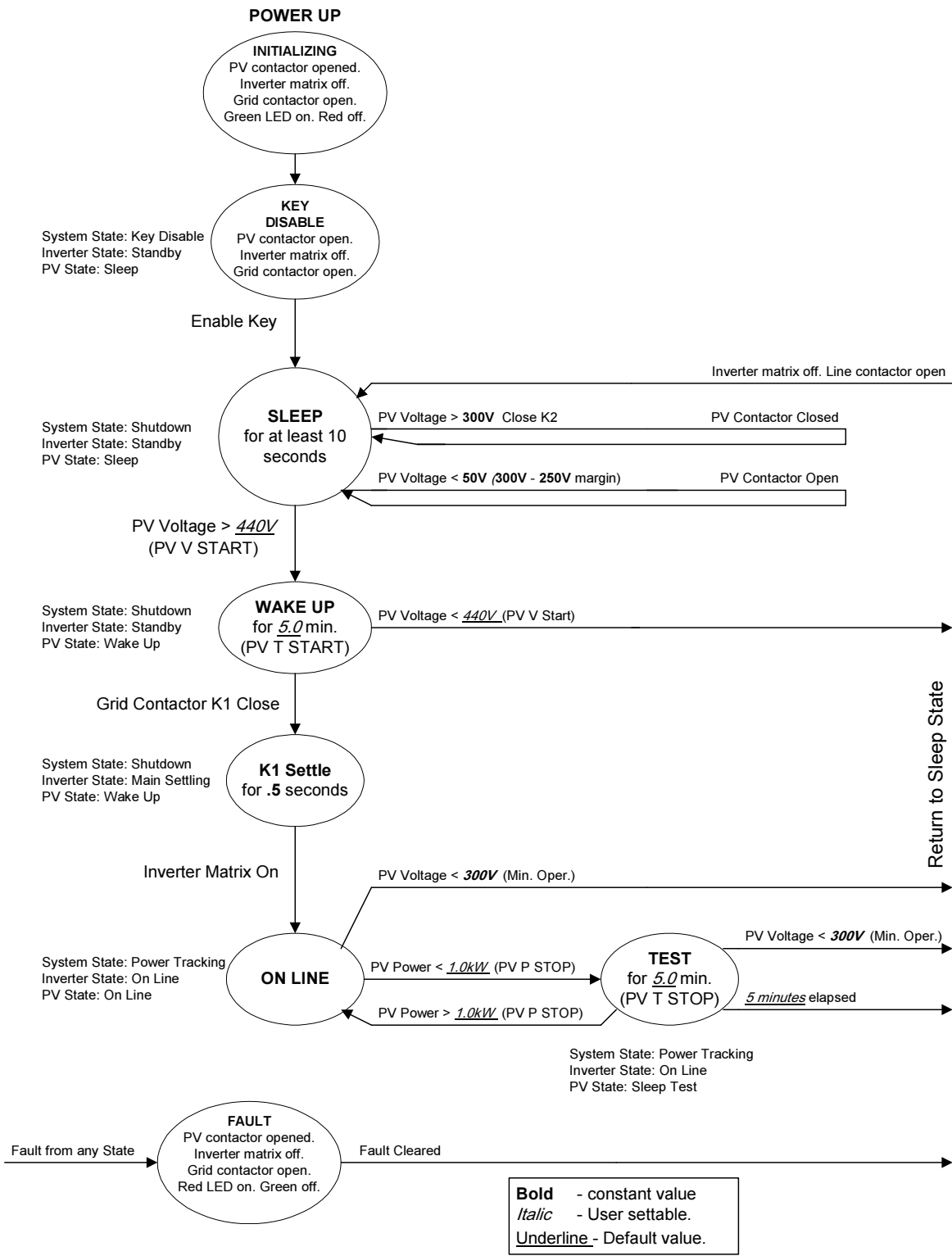

Figure 2-1 Operating States Flow Chart

Operating States

A state machine implemented within the CCU2 control software governs the operation of the PV225S with clearly defined transitions between its operating states. There are five steady-state operating states and numerous intermediate transition states.

- Power Tracking
- Transition
- Shutdown
- Fault
- Manual Current
- Matrix Test
- Automatic Sleep Test

Power Tracking

This is the standard operating state of the PV225S. The PV225S maximum power tracker will demand maximum power from the PV array, given sufficient PV irradiance.

The user should be aware of the following conditions governing PV225S state transitions:

- Qualified utility voltage must be present for all states of operation.
- Fault states are automatic from any state of operation. A fault will cause the PV225S to immediately stop processing all power. The fault condition will be reported to the operator interface LCD.
- Most PV225S faults are latching and must be cleared at the operator interface keypad before transitioning to another operating state.
- The **ON/OFF** switch, located on the front door of the PV225S, must be in the **ON** position for all operating states except Matrix Test, in which case it must be in the **OFF** position.

Transition

The intermediate transition states provide an orderly progression from one operating state to the next. The user has the ability to manually transition the PV225S between operating states via the operator interface keypad or remotely using the GUI software. Manual transitions are initiated by entering a “Goal State”, where the goal state is the desired operating state. Given all applicable system parameters are within acceptable limits, and the request is valid within the state machine, the PV225S will initiate the proper sequence of operations necessary to progress to the requested goal state. Refer to Figure 2-1 on page 2–3 for an illustration of valid state transitions.

Shutdown

The line interface controller is idle. The CCU2 monitors the status of the PV array and utility grid, waiting in standby until the PV array is available to produce power to the grid.

Fault

The PV225S has encountered a fault condition. When this happens, regardless of the PV225S state of operation, the PV225S will stop processing all power and execute an orderly system shutdown. A description of the fault and fault code will appear on the operator interface LCD. The Fault state may be cleared from the keypad once the cause of the fault has been corrected. See Chapter 4, “Troubleshooting” for a complete description of all fault codes.

Manual Current

This operating state is provided to evaluate the existing PV array V-I characteristics. The PV controller regulates a constant amount of PV current as commanded by the user from the operator interface keypad, up to the PV current limit of the PV225S. If the user commands more PV current than is available, the DC bus voltage will drop below the minimum bus voltage level and the PV225S will enter Shutdown mode.

Matrix Test

This operating state is provided to verify proper operation of the matrices and their associated control electronics. There is no power transfer between the PV and utility in this mode. The ON/OFF switch must be in the OFF position for the PV225S to enter this state.

Automatic Sleep Test

Toward the end of every solar day, the PV225S automatically determines when to stop producing power dependent upon the output power of the inverter. As the net output power of the PV225S nears zero, a timer is started to allow the inverter to ride through any brief irradiance reductions.

Operator Interface

The purpose of the operator interface is to provide a means of communicating critical operational information to and from the unit. This communication occurs between the operator and the UFCU Keypad and LCD display or between the operator and a personal computer running the Xantrex Solar GUI software.

UFCU Keypad Operation and LCD Display

The UFCU keypad is located on the front of the Main Inverter Enclosure to manipulate and view system operation and status.

The keypad is comprised of 20 touch-sensitive, piezoelectric keys that provide a means to navigate through the menus and alter user-changeable settings.

- Four function keys are available.
 - F1 - While in the READ Menu, this key is used to clear faults. In the WRITE Menu, it jumps to set “Goal:”.
 - F2 - While in the READ Menu, this key jumps to display “INV A Volts”. While in the WRITE Menu, this key jumps to display “Max AC Volts %”.
 - F3 - While in the READ Menu, this key jumps to display “PV Volts:”. While in the WRITE Menu, this key jumps to display “Input #0:”.
 - F4 - While in the WRITE Menu, when commanding a goal state, this function key confirms the change in goal state.
- Two Navigation keys are available.
 - V or ^ moves forward or backward within the menu structure. Upon reaching the end of the menu, it will roll-over to the beginning of the same menu.
- Ten numeric keys (0 through 9), two symbol keys (“.” and “-”), and an “ENTER” key are available for entering user-settable parameters.
- The “MENU” key allows you to enter the password-protected Write parameters.

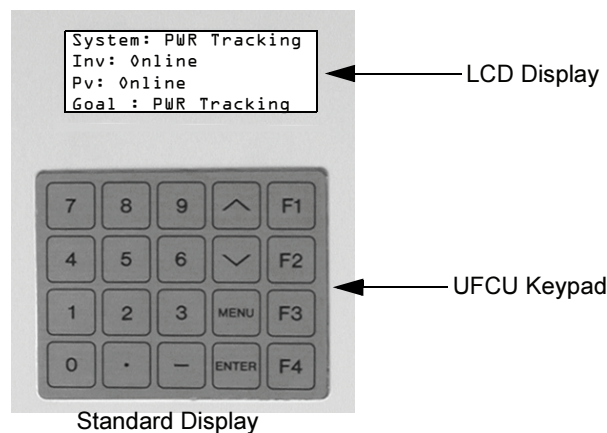

Figure 2-2 The Universal Front Panel Control Unit (UFCU) and LCD

LCD Display - Initialization Screen

Any time AC power is applied to the unit, the LCD display will cycle through the following displays while the system initializes. Once it's done with this process, the standard display will appear.

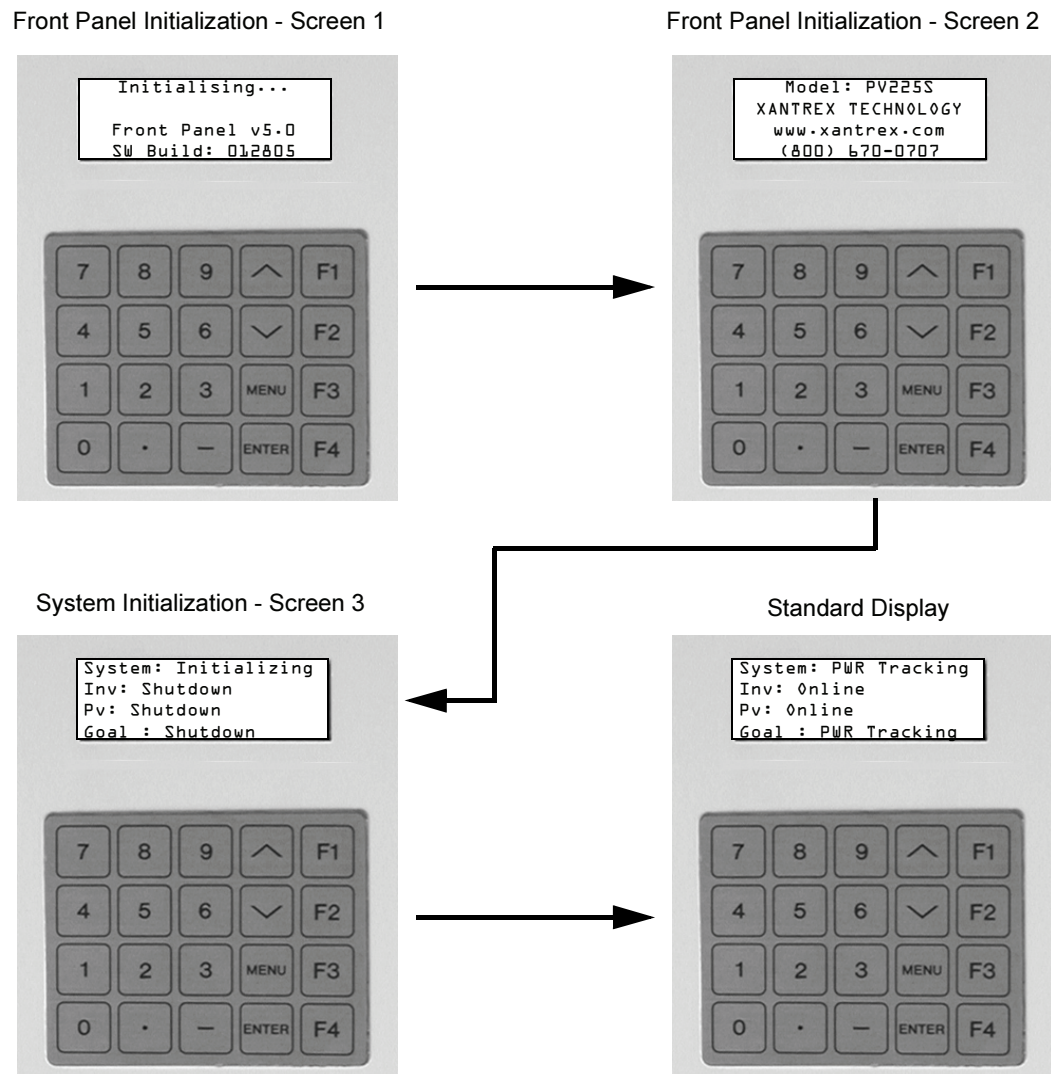

Figure 2-3 Initialization Screens

Standard Display

The Standard Display provides the following information:

- First Line - System Status (ID 1)
- Second Line - Inverter Status (ID 4)
- Third Line - PV Status (ID 13)
- Fourth Line - Goal State (ID 2)

Menu Structure

The operator interface consists of three levels:

- **READ Menu** - operation information provided *to* the user *from* the PV225S. The READ Menu consists of all operational values, the date and time. These can be viewed any time the PV225S has control power.
- **WRITE Menu** - operational parameters provided *to* the PV225S *from* the user. The WRITE Menu consists of a goal state sub-menu, and all system configurable parameters. The WRITE Menu is password protected and may only be changed by trained service technicians. In particular are parameters relating to utility protection setpoints.
- **Data Logging** - the collection of specific parameters values over a period of time. The data logging feature is only available if using the GUI. However, the user does have the ability to view a snapshot of specific data using the “Read by ID” feature. See Table 2-3 on page 2–14 and Table 2-4 on page 2–14.

Information reported back to the user (READ Menu) occurs at the LCD above the Universal Front Panel Control Unit (UFCU) and (if used) at the computer running the GUI monitoring program. Making changes to the parameters within the WRITE Menu is done with the UFCU keypad or the GUI software program and requires a password.

Important: *Specific grid-interface parameters within the WRITE Menu have been set in the factory to the limits mandated by UL 1741. Any changes to these setpoints should be agreed upon by the local utility and the equipment owner.*

Upon system power-up, the operator interface LCD will display the system operating state on the first line. The inverter’s state of operation will be reported on the second line. The PV Array’s state of operation will be reported on the third line. The Goal target will be reported on the fourth line.

Important: While in the WRITE Menu, the operator interface display will reset itself to the standard display if there is no input for more than 2 minutes.

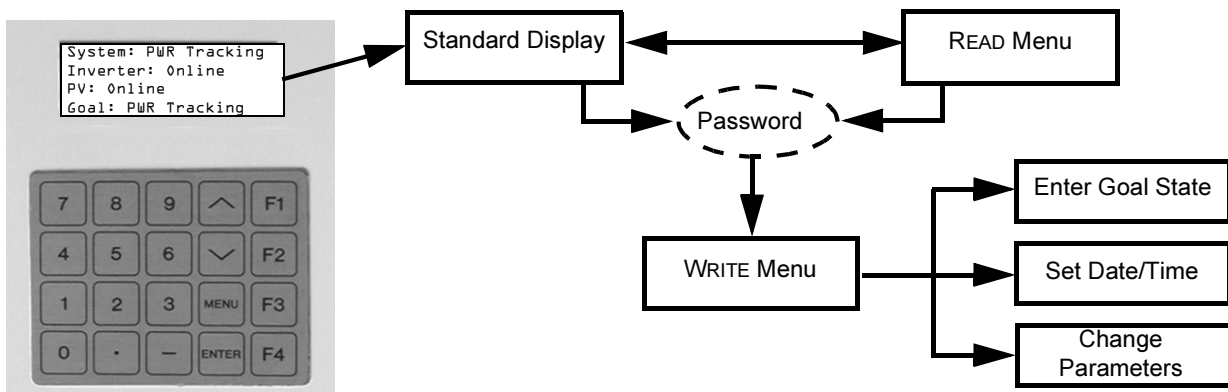

Figure 2-4 Operator Interface Menu Diagram

READ Menu

The READ Menu includes the following information:

- Current Operating State or Goal State
- Fault Code (if applicable)
- Inverter State
- Line Voltage and Current
- Inverter Matrix Temperature
- Inverter Power
- PV State
- PV Voltage and Current
- PV Power
- Grid Frequency
- Peak Power Tracker Enabled

Table 2-1 shows how the third and fourth line of the LCD will change as the operator continues scrolling through the Menu. Table 2-2 on page 2-11 provides a detailed description of READ Menu operational values that are displayed on the LCD.

To Display Any Operational Value in the READ Menu

From the Standard Display, use the \wedge or \vee keys on the operator interface keypad to scroll through the READ Menu. The fourth line of the display will change to display the appropriate information. See Table 2-1.

- The \vee key will scroll downward through the menu.
- The \wedge key will scroll upward through the menu.

Table 2-1 Scrolling through the Read Menu Parameters

Read Menu Value	Fourth Line of the LCD
Software Version (not shown)	CCU Vx.xx FP V.x.x
Date/Time (not shown)	Feb-14-2005 10:01:55
Read by ID#	Value by ID#
Inverter A-B Volt	INV A Volts:
Inverter B-C Volt	INV B Volts:
Inverter C-A Volt	INV C Volts:
Inverter A Current	INV A Amps:
Inverter B Current	INV B Amps:
Inverter C Current	INV C Amps:
PV Voltage	PV Volts:
PV Current	PV Amps:
PV Power	PV kW:
Grid Frequency	Grid Freq:
PV PPT Enable	PV PPT:
Ground Current	Ground I:
Accumulated Power	KWH:

Upon reaching the end of the menu, it will go back to the beginning of the menu.

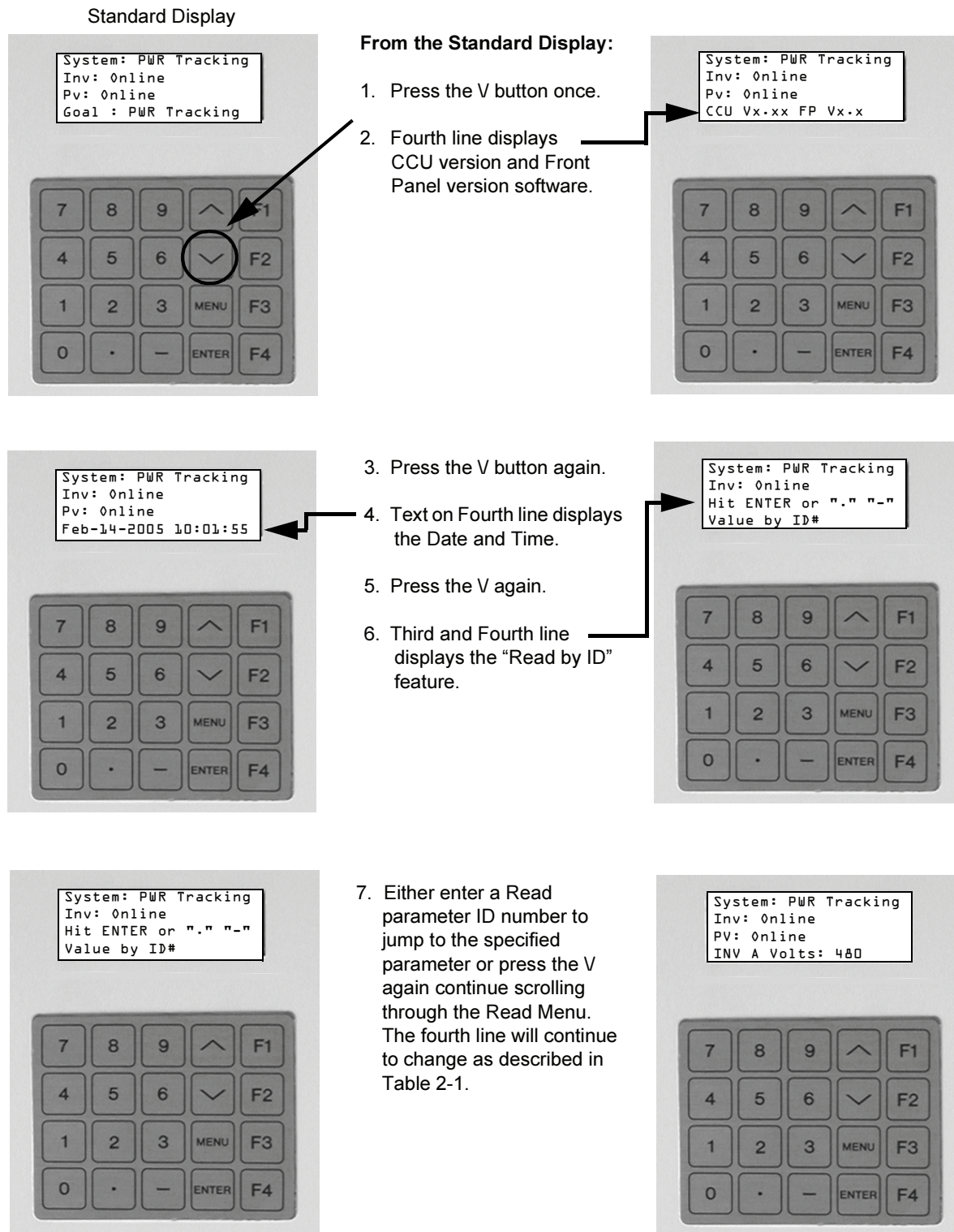

Figure 2-5 Scrolling through the READ Menu

Table 2-2 READ Menu Descriptions

Operational Parameter	Description	ID	Units
<p>Current Operating State</p> <p>Displays as: System: *</p> <p>where * can be any one of the states listed in the description for this parameter.</p>	<p>Current system states include the following.</p> <p> Initializing (0) Key-disabled (1) Shutdown (2) Starting (3) PWR Tracking (4) Manual Current (5) Matrix Test (6) Faulted (7)</p>	1	N/A
<p>System Goal State</p> <p>Displays as: Goal: *</p> <p>where * can be any one of the states listed in the description for this parameter.</p>	<p>Goal States include the following.</p> <p> Shut Down (0) PWR Tracking (1) Manual Current (2) Matrix Test (3)</p>	2	N/A
Fault code	See “Fault Code Descriptions” on page 4-4 for a detailed list of Fault Codes.	3	N/A
<p>Inverter State</p> <p>Displays as: INV: *</p> <p>where * can be any one of the states listed in the description for this parameter.</p>	<p>Inverter States includes the following.</p> <p> Shut Down (0) Stand-by (1) Starting (2) Main-Setting (3) On-Line (4)</p>	4	N/A
<p>Line A–B voltage</p> <p>Displays as: INV A volts: xxx</p>	Line to line voltage	5	V _{rms}
<p>Line B–C voltage</p> <p>Displays as: INV B volts: xxx</p>	Line to line voltage	6	V _{rms}
<p>Line C–A voltage</p> <p>Displays as: INV C volts: xxx</p>	Line to line voltage	7	V _{rms}
<p>Phase A current</p> <p>Displays as: INV A amps: xxx</p>	Phase A current	8	A _{rms}
<p>Phase B current</p> <p>Displays as: INV B amps: xxx</p>	Phase B current	9	A _{rms}

Table 2-2 READ Menu Descriptions

Operational Parameter	Description	ID	Units
Phase C current Displays as: INV C amps: xxx	Phase C current	10	A _{rms}
Inverter Real Power Displays as: INV kW:	Inverter Real Power	11	kW
Inverter Matrix Temperature Displays as: INV Temp:	Temperature of the Inverter IGBT matrix heatsink	12	°C
PV State Displays as: PV: * where * can be any one of the states listed in the description for this parameter.	PV States include the following. Shut Down (0) Sleep (1) Wakeup (2) On-line (3) Sleep-test (4)	13	N/A
PV Voltage Displays as: PV Volt: xxx	PV Voltage	14	Vdc
PV Current Displays as: PV amps: xxx	PV Current	15	Adc
PV Power Displays as: PV kW: xxx	PV Power	16	kW
Grid Frequency Displays as: Grid Freq:	Grid Frequency	17	Hz
Peak Power Tracker Enable Displays as: PV PPT: * where * can be any one of the states listed in the description for this parameter.	Indication as to whether the PPT is enabled or disabled. Off (0) On (1)	18	N/A
Ground Current Displays as: Ground I:	Ground Current	19	N/A
kW Accumulated Displays as: kWh:	kW Accumulated	20	N/A

READ-by-ID

The Read-by-ID feature supports the ability of the user to view any Read or Write parameter available within the menu structure. It also provides a means to view data logging and accumulated values information. See Table 2-2 for a list of the Read Menu parameters. See Table 2-3 for a list of data logging menu parameters. See Table 2-4 for a list of accumulated values parameters.

To use the Read-by-ID Feature:

1. From the Standard Display, press the \vee key three times to scroll downward through the menu to the Read-by-ID Menu item. Stop when the 3rd and 4th line of the display change as shown in Figure 2-6.
2. Press \langle ENTER \rangle to enter the Read-by-ID feature.
3. Use the keypad to enter the ID number of the Data Log Configuration or Accumulated Value ID number and press \langle ENTER \rangle . See Table 2-2 for a list of **READ** Menu items and their ID numbers.
 - a) Press the “.” button to move upward in the Menu structure.
 - b) Press the “-” to move backward in the menu structure. These keys only function in the Read-by-ID feature.

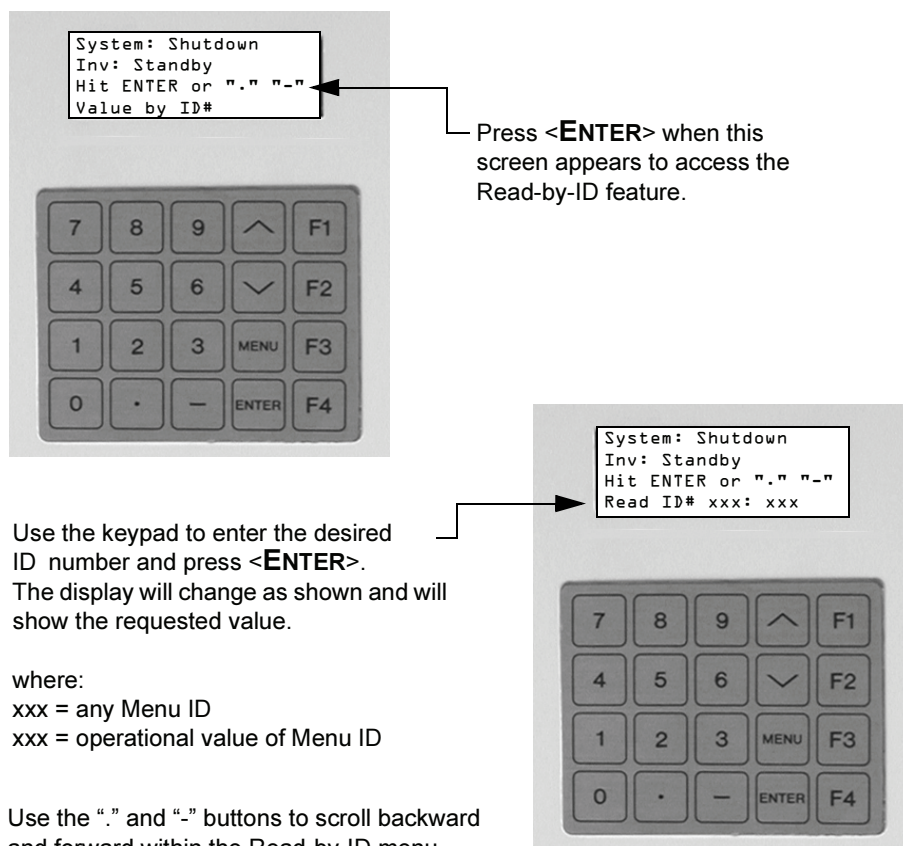

Figure 2-6 Read-by-ID Feature

Table 2-3 provides a list of the Data Logging Menu parameters.

Table 2-3 Data Logging Menu

ID#	Usage
300	Data Log Daily Rate in Minutes
301	ID# of 1st parameter to be logged
302	ID# of 2nd parameter to be logged
303	ID# of 3rd parameter to be logged
304 through 390	ID#s of the 4th through the 90th parameter to be logged.
391	Not available
392	Data Log Nightly Rate in Minutes
393	First Daytime Hour
394	First Night-time Hour
395	Size of Data Log in Words
396	Words per record
397	Count of parameters per record
398	Offset from Data Log or next log record
299	Address of the Data Log

Table 2-4 provides a list of the Accumulated Values Menu parameters.

Table 2-4 Accumulated Values Menu

ID#	Usage
600	Accumulated Operating Hours on actual day
601	Accumulated Operating Hours in actual week
602	Accumulated Operating Hours in actual month
603	Accumulated Operating Hours in actual year
604	Accumulated Operating Hours since Commissioning
605	Accumulated Sell Mode Hours on Actual Day
606	Accumulated Sell Mode Hours in actual week
607	Accumulated Sell Mode Hours in actual month
608	Accumulated Sell Mode Hours in actual year
609	Accumulated Sell Mode Hours since Commissioning
610-619	Not available
620	Accumulated Power Sold Hours on actual day
621	Accumulated Power Sold Hours in actual week
622	Accumulated Power Sold Hours in actual month
623	Accumulated Power Sold Hours in actual year
624	Accumulated Power Sold Hours since Commissioning
625	Accumulated Power Sold Hours since last reset
626-629	Not available
630	Peak Power monitored today

Table 2-4 Accumulated Values Menu

ID#	Usage
631	Peak Power monitored this week
632	Peak Power monitored this month
633	Peak Power monitored this year
634	Peak Power monitored since Commissioning
635-639	Not available
640	Peak Power Sold for a day
641	Peak Power Sold for a week
642	Peak Power Sold for a month
643	Peak Power Sold for a year

WRITE Menu

Important: *Specific grid-interface parameters within the WRITE Menu have been set in the factory to the limits mandated by UL 1741. Any changes to these setpoints should be agreed upon by the local utility and the equipment owner.*

The WRITE Menu includes the following parameters:

- Ground Current Max
- PPT Voltage Reference
- PV Voltage Start
- PV Time (Start and Stop)
- PV Power Stop
- PPT Current Max %
- Manual Current %
- PPT Enable
- PPT Update Rate and Voltage Step

Important: Write parameters require a password to access and should only be changed by authorized personnel.

Table 2-5 provides a detailed description of WRITE parameters that are displayed on the LCD.

Changing and Displaying WRITE Menu Parameter Values

Follow the procedure below to change **WRITE** Menu parameters.

To change **WRITE** Menu parameters:

1. From the standard display or anywhere in the **READ** Menu, you may access the **WRITE** menu parameters by pressing the <MENU> key. This will ask for a password.
2. Enter the password <5><9><4> and press the <ENTER> button.
 - a) If the wrong password is entered, the display will again prompt the user for the password.
 - b) If a mistake is made while keying in the password, the ^ or V keys may be used as a backspace key.
3. Once within the Write Menu, the first item is the “Set Goal State”. Use the ^ or V key on the operator interface keypad to scroll through the **WRITE** Menu parameters.
 - a) To change the displayed parameter, press the <ENTER> button.
 - b) Enter the desired value and press <ENTER>. If the value entered is outside the acceptable range for the parameter, the original value will remain.
 - c) To leave the **WRITE** Menu and return to the **READ** Menu, press the <MENU> button once and the standard display will reappear on the LCD.

Table 2-5 Write Menu Parameters

Parameter	Description	ID	Units	Default Value	Maximum Value	Minimum Value
Set Goal State Displays as: Hit ENTER to set Goal:	Commands a Goal State.					
Set Date Displays as: 042805	The date is entered month-day-year (mmddyy): April 28, 2005 is entered 042805.					
Set Time: Displays as: 163000	The time is entered in military hours-minutes-seconds (i.e., 24-hour clock): 4:30 pm is entered 163000.					
Maximum Grid Voltage Displays as: Max AC Volts %:	This parameter sets the trigger point value for “AC voltage High” (0013) fault. If the grid voltage is over this parameter’s value, the fault is triggered. The upper limit of this parameter is restricted by UL requirements.	32	Percentage of Nominal voltage	110	110	105

Table 2-5 Write Menu Parameters

Parameter	Description	ID	Units	Default Value	Maximum Value	Minimum Value
Minimum Grid Voltage Displays as: Min AC Volts%:	This parameter sets the trigger point value for “AC voltage low” (0012) fault. If the grid voltage is below this parameter’s value, the fault is triggered. The lower limit of this parameter is restricted by UL requirements.	33	Percentage of Nominal voltage	88	95	88
Maximum Grid Frequency Displays as: Max AC Freq:	This parameter sets the trigger point value for “AC frequency high” (0011) fault. If the grid frequency is over this parameter’s value, the fault is triggered. The upper limit of this parameter is restricted by UL requirements.	34	Hertz	60.5	60.5	59.5
Minimum Grid Frequency Displays as: Min AC Freq:	This parameter sets the trigger point value for “AC frequency low” (0010) fault. If the grid frequency is below this parameter’s value, the fault is triggered. The lower limit of this parameter is restricted by UL requirements.	35	Hertz	59.5	59.5	60.5
Maximum Ground Fault Current Displays as: Max Gnd Flt I	This parameter sets the trigger point value for “Ground Over Current” (0033) fault. Once the current through the ground cable is greater than the value of this parameter, the fault is triggered.	36	Amps	10	20	1
Peak Power Tracker Reference Voltage Displays as: PPT V Ref:	This is the initial PV voltage the inverter is going to try to keep as it goes into on line mode. If the power tracker is off, the inverter will draw current from the PV array to maintain this reference voltage. If the power tracker is on, this is the reference voltage from which the inverter start exploring voltages that produce more power.	37	Volts	400	600	300
PV Wakeup Voltage Displays as: PV V Start:	This is the trigger point that transitions the inverter from PV Sleep state to PV Wake Up state. When the PV voltage reaches the value of this parameter the inverter transitions into PV Wake Up mode.	38	Volts	440	600	300

Table 2-5 Write Menu Parameters

Parameter	Description	ID	Units	Default Value	Maximum Value	Minimum Value
Time Delay for PV Wake up Displays as: PV T Start:	Time delay to transition from PV wake up state to PV On-line state. Once the inverter is in PV Wake Up mode, it waits for the amount of time determine by this parameter before transitioning into PV on-line mode. During this time the inverter checks that the PV voltage is no less than the PV wake voltage, otherwise it goes into PV Sleep mode.	39	Seconds	300	1200	0
Time delay for PV Sleep Test Displays as: PV T Stop:	This is the amount of time the inverter will be in Sleep Test mode if the output power continues to be below “PV P Stop”. The inverter will exit Sleep Test mode towards on-line mode if the power is over “PV P Stop” or towards Shutdown mode if the “PV T Stop” timer expires.	40	Seconds	300	1200	0
PV Output Power to Enter Sleep Test Mode Displays as: PV P Stop:	This is the output power trigger point for the inverter to transition into sleep test mode. When the output power is below the value of this parameter the inverter enters sleep test mode.	41	KW	1	10.0	0.1
Power Tracker Maximum Output Power Displays as: I PPT Max:	This parameter sets the percentage of maximum rated power the inverter will produce when in power tracker mode. For example, a 100 Kw system with this parameter set to 50 will not attempt to produce more than 50 Kw.	42	Percentage of maximum output power.	100	110	0
Manual Current Output Displays as: I Manual:	This parameter sets the percentage of maximum out current the inverter will attempt to produce while in manual current mode.	43	Percentage of maximum output current.	25	110	0

Table 2-5 Write Menu Parameters

Parameter	Description	ID	Units	Default Value	Maximum Value	Minimum Value
Enable Peak Power Tracker Displays as: PPT Enable:	This parameter switches on and off the Power Tracker function. When the Power Tracker is on, the inverter will regulate the bus voltage to optimize output power. When the Power Tracker is off, the inverter will regulate the bus voltage to maintain it at “PPT V Ref” volts.	44	0 = Off 1 = On	1	1	0
Power Tracker Rate Displays as: PPT Rate:	This parameter sets the rate at which the Power Tracker function makes changes to the voltage reference point as it tries to find the optimal position. For example, if the value of this parameter is 0.5, then every half a second the power tracker will increase or decrease the voltage reference point to check if more power can be produced at the new level.	45	Seconds	0.5	10.0	0.1
Power Tracker Step Displays as: PPT V Step:	This parameter sets the size of the change the Power Tracker will make to the voltage reference point as it tries to find the optimal position. For example, if the value of this parameter is set to 1, the Power Tracker will increase or decrease the voltage reference point by one volt at a speed of “PPT Rate” to check if more power can be produced at the new level.	46	Volts	1	10.0	0.1

Commanding Goal State Changes

To change the Goal State:

1. From the standard display press the <MENU> key. This will prompt the user for a password. The LCD will change the third line of the display to “Type and Hit ENTER” and fourth line of the display to “Password:”.
2. Enter the password <5><9><4> and press the <ENTER> button. The LCD will change the third line of the display to “Hit ENTER to set” and fourth lines of the display to “Goal:”.
3. Press <ENTER> again. The Goal State menu will show on the LCD display.
4. Scroll through the goal state menu with the ^ or v keys until the desired goal state is displayed on the fourth line of the display.
5. Press <ENTER>. The LCD will then prompt the user by displaying the following text on the third line: “Press F4 to Confirm”.
6. Press <F4> and the PV225S will transition to this goal state. If the goal state requested violates the conditions of the state machine, the PV225S will remain in the previous state of operation.

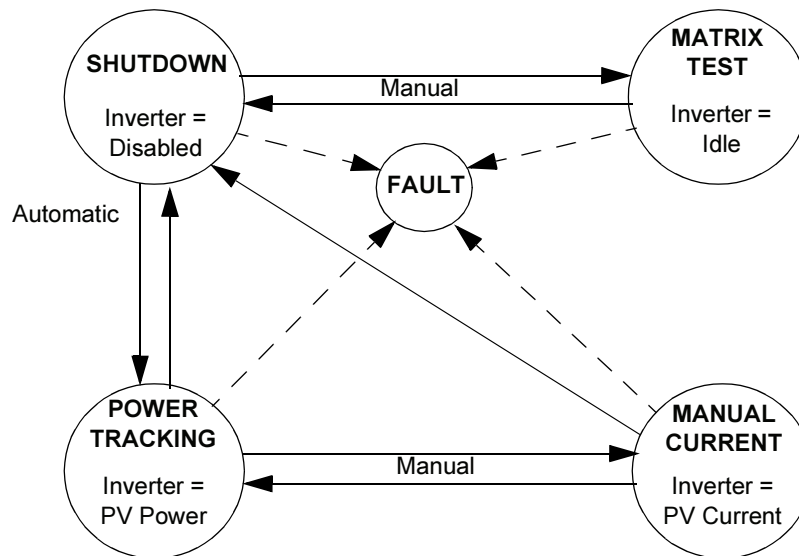

Figure 2-7 State Transition Diagram

Setting the Date and Time

Follow the procedure below to change the date and time.

To change the Date and Time:

1. From the standard display, press the <MENU> key. This will prompt the user for the password. The LCD will change the third and fourth lines of the LCD display as follows:
 “Type and Hit ENTER”
 “Password:”.
2. Enter the password <5><9><4> and press the <ENTER> button.
3. Scroll down with the V key until date or time parameters are reached.
 - a) If you’re changing the date, the third and fourth lines of the LCD will display as follows:
 “Type and hit ENTER”
 “Set Date: MMDDYY”
 - b) If you’re changing the time, the third and fourth lines of the LCD will display as follows:
 “Type and hit ENTER”
 “Set Time: HHMMSS”
4. Press <ENTER>. Enter the proper date or time in a six digit format. *For example:*
 - a) The date is entered month-day-year (mmddyy):
 April 28, 2005 is entered 042805 <ENTER>.
 - b) The time is entered in military hours-minutes-seconds (i.e., 24-hour clock): 4:30 pm is entered 163000 <ENTER>.

If a mistake is made while entering the date or time, the ^ and V keys may be used as a backspace key. Any two-digit year “YY” may be entered for the date, but regardless of the keyed entry, the maximum Month/Day “MMDD” that the UFCU will accept is a “1231” or Dec. 31st. The maximum allowable time entry the UFCU will accept is “235959”.
5. Once the entry is accepted, the third and fourth lines of the LCD display will revert back to the following:
 - a) If you’re changing the date, the third and fourth lines of the LCD will display as follows:
 “Hit ENTER to set”
 “Set Date:”
 - b) If you’re changing the time, the third and fourth lines of the LCD will display as follows:
 “Hit ENTER to set”
 “Set Time:”
6. Pressing the <MENU> key will return the user to the standard display.

Manual State Transitions

State conditions can also be transitioned manually. Refer to “Commanding Goal State Changes” on page 2–20 for instructions on commanding PV225S goal states for manual transitions.

Shutdown → Matrix Test → Shutdown

1. Turn the **ON/OFF** switch to the **OFF** position.
2. Command the PV225S to the Matrix Test.
3. After completing the Matrix Test, command the PV225S to Shutdown.

If the **ON/OFF** switch is turned to **ON** while the PV225S is in the Matrix Test state, the PV225S will transition to Shutdown.

Power Tracking → Manual Current → Power Tracking or Shutdown

1. Verify the PV manual current parameter (I_{Manual}) is set to the desired percent of rated.
2. Command the PV225S to Manual Current mode from the operator interface keypad. While in the manual current mode, the user may change the PV manual current parameter. *However, the user may demand greater current than the capacity of the PV array. If this causes the PV voltage to drop below the minimum operating voltage (300 Vdc), the PV225S will transition to Shutdown.*
3. To exit the Manual Current mode, the user must manually command the PV225S to Power Tracking.

Automatic State Transitions

State conditions can also be transitioned automatically. Refer to “Commanding Goal State Changes” on page 2–20 for instructions on commanding PV225S goal states.

Shutdown → Power Tracking → Shutdown

1. The **ON/OFF** switch must be turned to the **ON** position.
2. Once the PV voltage exceeds the PV voltage start set point ($PV_{V_{Start}}$) the PV225S will start a wake-up timer ($PV_{T_{Start}}$).
 - a) If the PV voltage remains above the PV start voltage set point for the duration of the wake-up timer, the PV225S will transition to Power Tracking.
 - b) If the PV power drops below the PV power stop set point, ($PV_{P_{Stop}}$) the PV225S will start a PV sleep timer ($PV_{T_{Stop}}$).
 - c) If the PV voltage and power remain below their respective setpoints for the duration of the sleep timer, the PV225S will transition to Shutdown.

Any State → Fault

If the PV225S encounters a fault, regardless of operating state, it will transition to the Fault state. The PV225S will remain in this state until the fault condition has been remedied and cleared. The Fault Code number will appear on the first line of the LCD. A description of the fault will show on the second line. The third line of the LCD will read “F1 to Clear Fault?”. The fourth line shows the goal state.

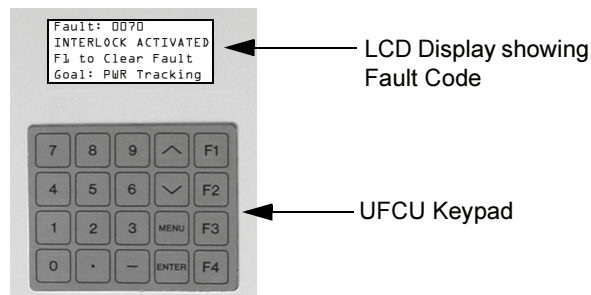

Figure 2-8 LCD showing Fault Code

To clear the fault:

1. See Table 4-1, “Fault Codes” on page 4-4 for a complete listing of Fault Codes and possible remedies. Correct the fault condition if possible and attempt to clear the fault by pressing “F1”.
2. The ability to clear the fault can only be done from the **READ** Menu. If a fault occurs while accessing the **WRITE** Menu, pressing <MENU> once will return to the Read Menu, and “F1 to Clear Fault” will appear on the third line of the LCD display.

Auto-restart Feature

In the event of a utility voltage or frequency excursion outside of those specified in Table A-3 on page A-3, the PV225S will automatically transition to a Fault condition. Once the Utility recovers for a period of five minutes, the PV225S will automatically clear the fault, then resume normal operation.

Energize Procedure (Startup)

To start up the PV225S:

1. Remove any lockout devices from the Utility connection circuit breaker and PV disconnect switch.
2. Close the Utility connection circuit breaker.
3. Close the AC Disconnect Switch.
4. Close DC Disconnect Switch.
5. Turn the ON/OFF switch to the ON position.

After a 15 second initialization period, the PV225S will automatically transition to 'Waking Up', given the PV voltage is greater than the PV V Start set point.

De-Energize/Isolation Procedure (Shutdown)

The following procedure should be followed to de-energize the PV225S for maintenance:



WARNING

The terminals of the DC input may be energized if the PV arrays are energized. In addition, allow 5 minutes for all capacitors within the main enclosure to discharge after disconnecting the PV225S from AC and DC sources.

To isolate the PV225S:

1. Turn the ON/OFF switch to the OFF position.
2. Open the DC Disconnect Switch.
3. Open the AC Disconnect Switch.
4. Open the utility connection circuit breaker.
5. Install lockout devices on the utility connection circuit breaker and DC Disconnect Switch.

Computer Communications with the PV225S

The PV225S provides multiple options for communicating system status or data logging through a personal computer using the Xantrex Solar Graphic User Interface (GUI) software.

The Xantrex Solar Graphic User Interface (GUI) software is a Windows™-based program that:

- displays system status,
- accesses inverter controls,
- accesses metering and data logging capabilities, and
- controls protective functions.

If multiple inverters are networked together, the software is capable of tracking up to 50 inverters on the same network.

Determine which method will be used to communicate with the PV225S and ensure the appropriate hardware is in place before proceeding with installing the GUI. See the “PC Connection Methods” section of the PV225S 225 kW Grid-tied Photovoltaic Inverter Planning and Installation Manual for instructions on establishing the desired connection if this has not already been done.

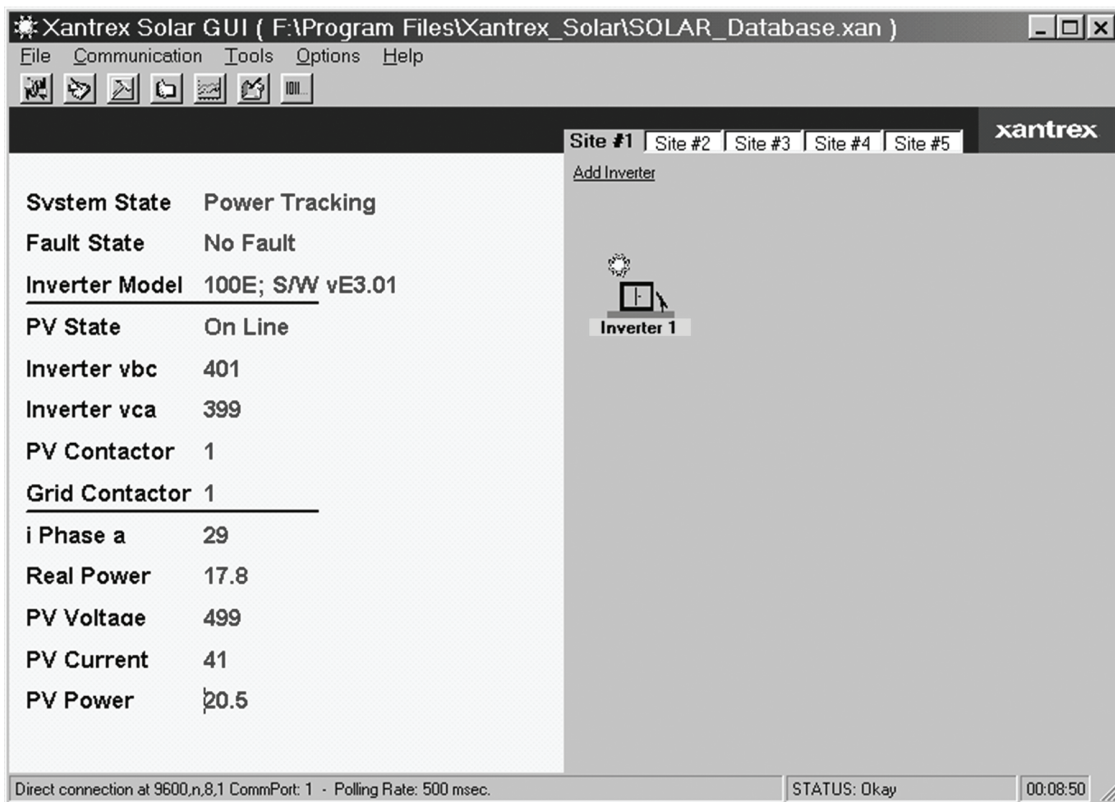

Figure 2-9 GUI Interface Main Menu Screen

Installing the Graphic User Interface (GUI) Software

The following section outlines the minimum system requirements for using the GUI software and instructions for installing, configuring, and using the software. Close all programs running on the computer before proceeding with the installation.

Minimum System Requirements

The following lists the minimum requirements for using the Xantrex Solar Graphic User Interface (GUI) Software.

- Personal Computer with a 486DC/66 MHz or higher processor; Pentium™ or higher processor recommended.
- Microsoft Windows™ operating system (Win98 or later).
- 50 MB of free hard disk space.
- 64 MB of RAM (128 MB recommended)
- 56K modem (minimum)
- If using a LAN to access the inverters, a LAN card will be required in the PC.

Starting the Software Setup Program

Select one of the following methods to install the software:

- Use Autorun (must be enabled on your CDROM drive).
- Manual Start (assumes that Autorun is not enabled on your CDROM drive).
- Use a Command prompt to initiate the installation program.

Important: Software levels shown in the following illustrations may not represent the most current version.

Starting the Setup Program Using Autorun

To install the software with Autorun enabled on your CDROM drive:

1. Insert the CD into your computer's CDROM drive. If autorun has not been disabled for the CDROM in your computer, the Model Specific Software Installation window shown in Figure 2-11 will appear.

Starting Setup Manually

To start the program from the CD if Autorun is disabled on your computer:

1. Insert the **XANTREX SOLAR INVERTER GUI – INSTALLATION CD** into your CDROM drive.
2. Open Windows Explorer (or Click My Computer) and navigate to the CDROM drive to view the contents of the disk.
3. Double-click on the file *GUI_Menu.exe* icon. The splash screen shown in Figure 2-11 will appear.
4. Proceed to the Model Specific Software Installation section on page 2–28 to continue with the installation.

Starting Setup From a Command Prompt

To start the program from a command prompt:

1. Insert the **XANTREX SOLAR INVERTER GUI – INSTALLATION CD** into your CDROM drive.
2. Click on **START** and select “**RUN**”.
3. Enter the drive letter assigned to your CDROM and the name of the installation program as shown in Figure 2-10.

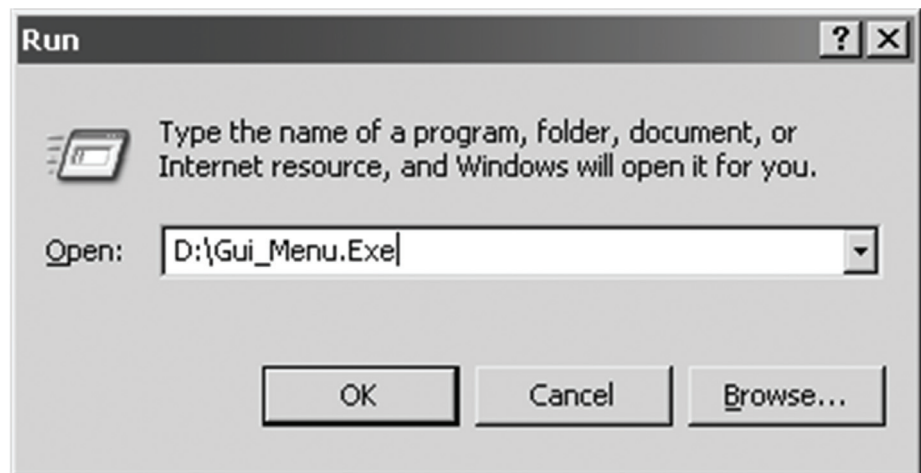

Figure 2-10 Starting Setup from a Command Prompt

Important: The drive letter assigned to your CDROM may be different from the one shown in Figure 2-10. Be sure to use the correct letter for your drive or the program will not start.

4. Click **OK**. The splash screen shown in Figure 2-11 will appear.
5. Proceed to the Model Specific Software Installation section on page 2–28 to continue with the installation.

Model Specific Software Installation

Once the Setup program has been started, installation of the GUI software can continue.

To continue with the GUI software installation:

1. After the GUI Setup Splash Screen appears (Figure 2-11), click on the button **INSTALL PV225S GUI**. The GUI Setup Welcome Window will appear next (Figure 2-12).

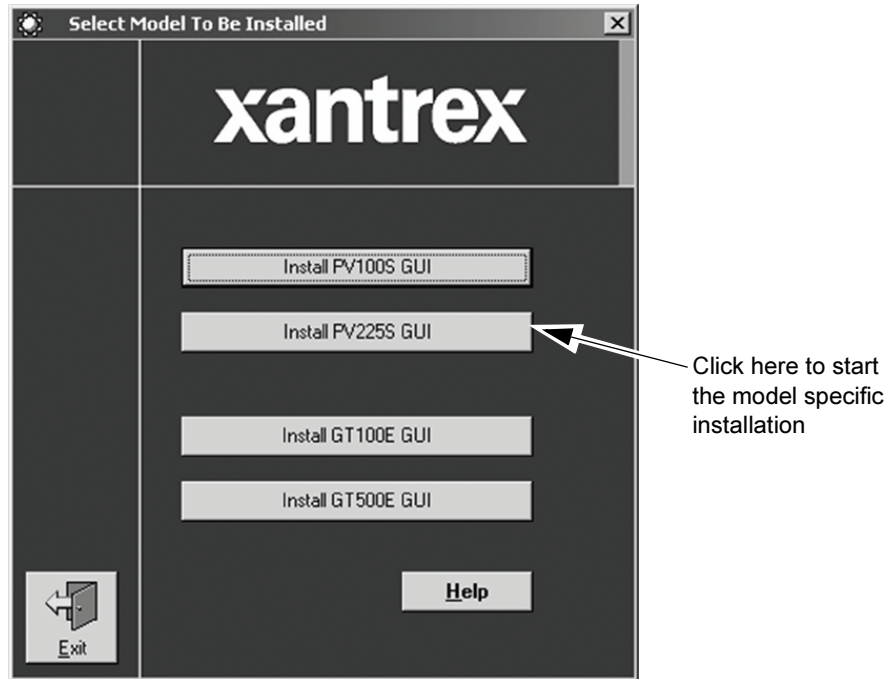

Figure 2-11 GUI Splash Screen



Figure 2-12 GUI Setup Welcome Window

2. Click **OK** and the following window will appear:

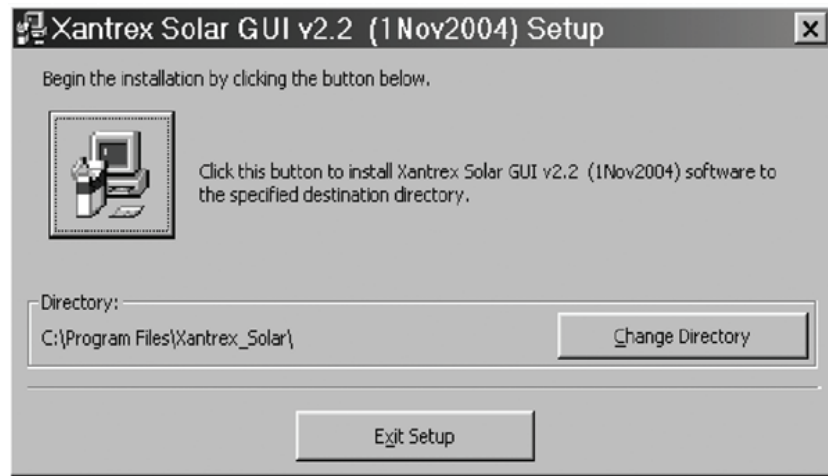

Figure 2-13 GUI Setup Start Window

If the directory provided in this window is acceptable for the installation, proceed to Step 4. If not, click on the **CHANGE DIRECTORY** button and provide a new name for the desired destination directory.

3. Click on the picture of the computer to continue with the installation.
The following window will appear:

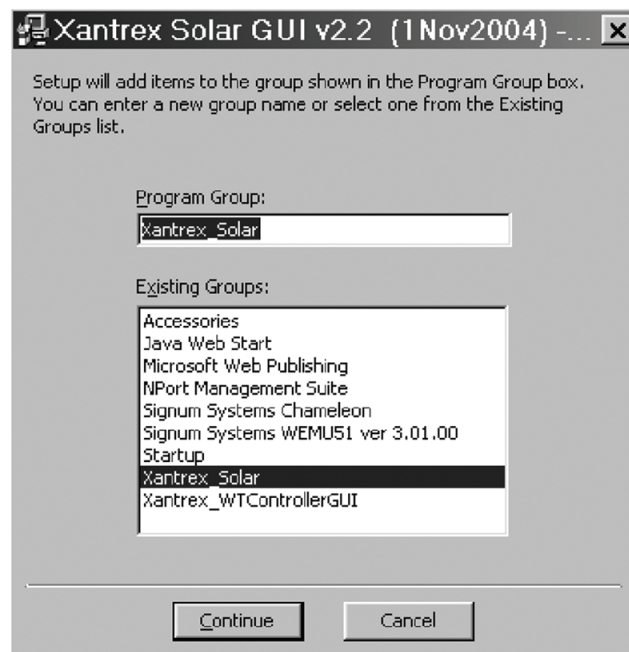

Figure 2-14 GUI Setup Program Group Window

4. Click **CONTINUE** to confirm the program group to be used.
The following setup progress indication window will appear.

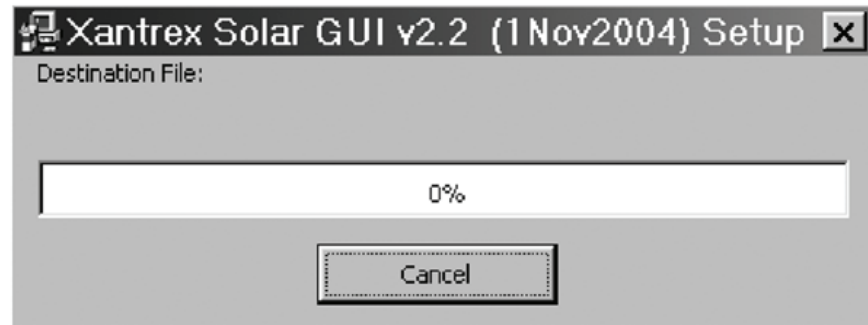

Figure 2-15 GUI Setup Progress Indicator Window

5. When completed, you will see this:

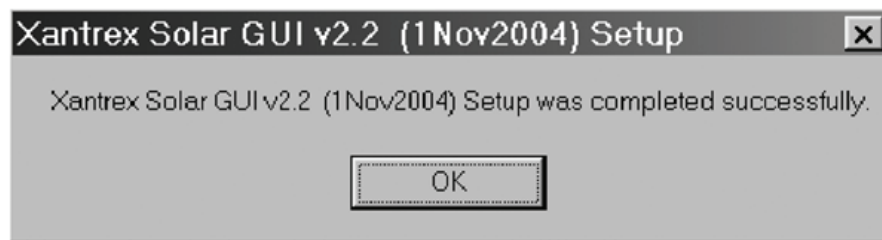

Figure 2-16 GUI Setup Start Window

6. Click **OK**. The GUI is now installed on the computer.

Running the GUI

To run the GUI software program, log onto the computer and click the following menu items in the order shown below.

1. Window's **START** button
2. **PROGRAMS**
3. **XANTREX_SOLAR**
4. **XANTREX SOLAR GUI**

Remote/LAN Connection

If no inverter is connected to the COM1 serial port of the computer, the following screen will appear:

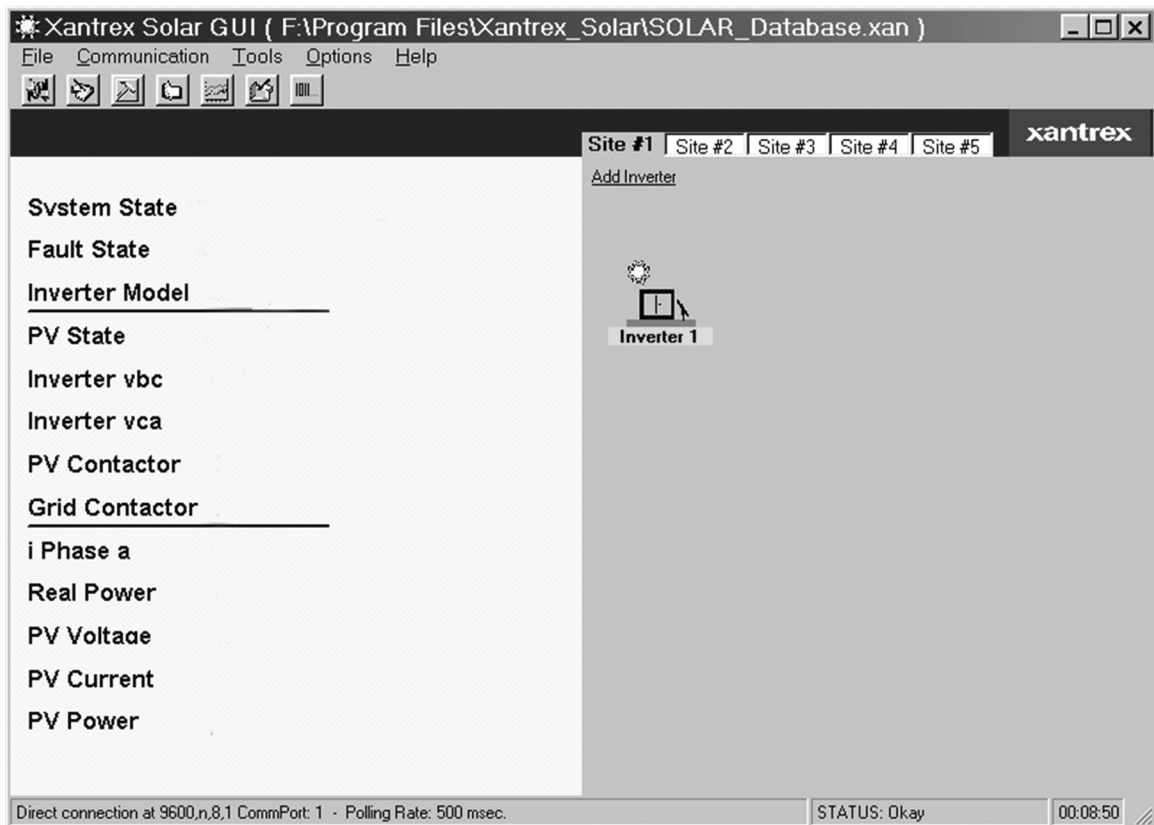

Figure 2-17 GUI Interface Screen if Connected Remotely

Direct Connection

If the serial communication port of the inverter is connected to the COM1 serial port of the computer, the following screen will appear.

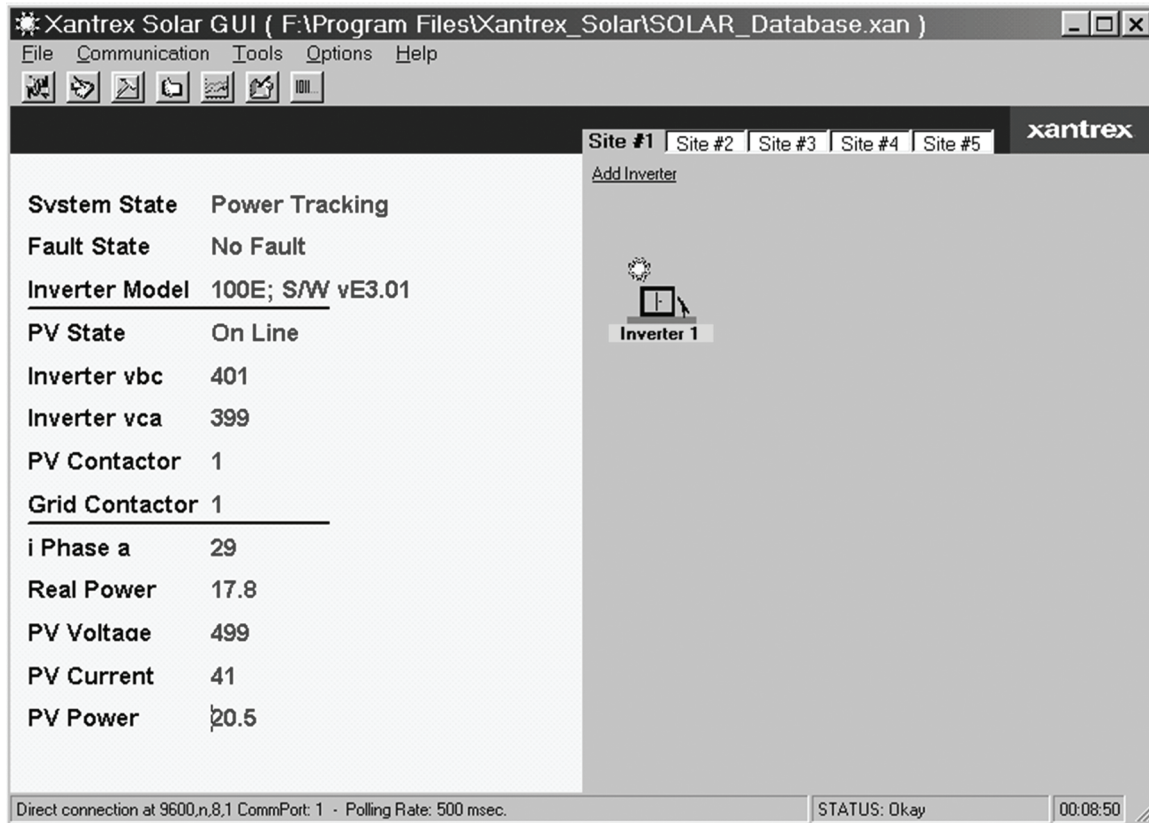

Figure 2-18 GUI Interface Screen if Connected Directly

GUI Configuration - Adding Inverters

Once the GUI has started, you will need to configure each Inverter icon to reflect the appropriate operational parameters for each inverter that is connected to the system. The software automatically defaults to one inverter. To program that inverter accordingly, follow the directions provided below.

To configure the inverters in the GUI:

1. With the GUI Main Menu open, Right-click on the “Inverter 1” icon.
2. Click on the tabs to display each page and fill out the required information.
3. Fill out the **Detail** Information in the form shown in Figure 2-19.

Form Tab

Fill out all the required information on this form.

The screenshot shows a window titled "Inverter 'Inverter 1' at Site #1". At the top, there are three tabs: "Connection", "Detail", and "Operational Configuration". The "Detail" tab is selected and circled in red. An arrow labeled "Form Tab" points to this tab. The form contains several input fields: "Inverter Name" (with "Inverter 1" entered), "Inverter S/N", "Warranty Exp.", "CCU Software", "Inverter Model", "Commissioned", "CCU S/N", "F.P. Software", "Location" (with sub-fields for Street, City, State, Zip Code, and Country), and a checked checkbox for "Inverter Icon Visible". On the right side, there are three buttons: "Remotely", "Local", and "End". An "OK" button is located at the top right of the window.

Figure 2-19 Detail Screen

4. Fill out the **Contact** Information in the form shown in Figure 2-20.

Form Tab

Fill out all the required information on this form.

The screenshot shows the same window as Figure 2-19, but the "Contact" tab is selected and circled in red. An arrow labeled "Form Tab" points to this tab. The form contains several input fields: "First Name", "Last Name", "Title", "Phone #", "Cell Phone #", "Fax #", "Pager #", "e-mail", "Street", "City", "State", "Zip Code", and "Country". On the right side, there are three buttons: "Remotely", "Local", and "End". An "OK" button is located at the top right of the window.

Figure 2-20 Contact Screen

5. Fill out the **Operational Configurations** Information in the form shown in Figure 2-21 through Figure 2-23. This section has four sub-menu pages to cover the following parameters.
 - a) Fill out Operational Limits Information requested.
 - b) Click on the PV Sub-menu to continue.

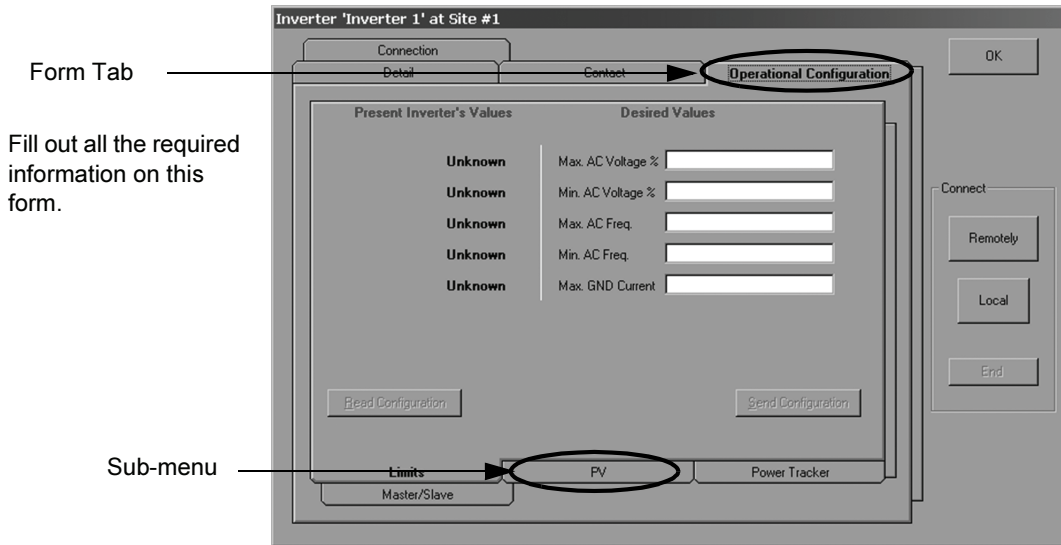

Figure 2-21 Operational Configuration Screen - Limits

- c) Fill out PV Information requested.
- d) Click on the Power Tracker Sub-menu to continue.

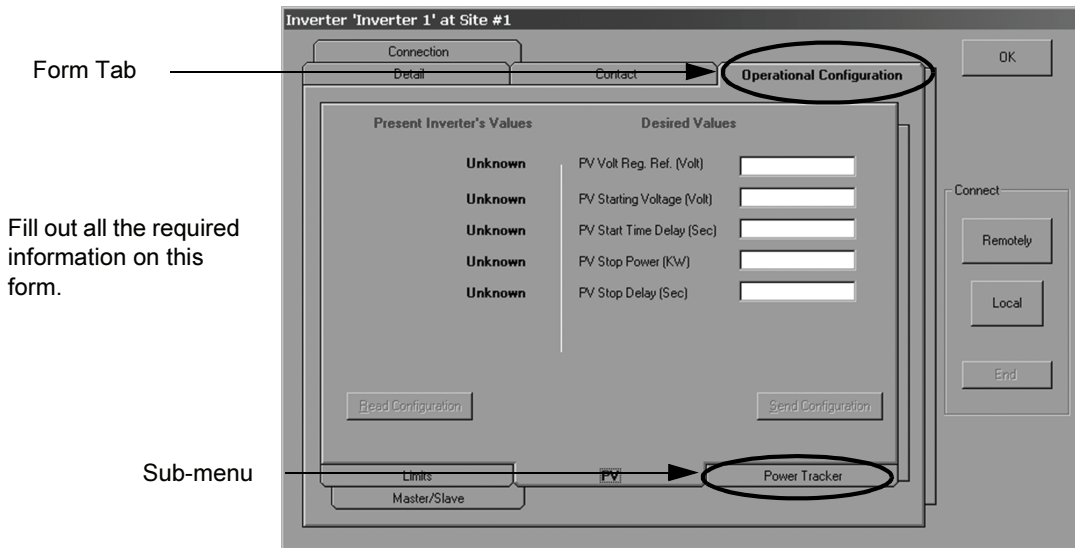

Figure 2-22 Operational Configuration Screen - PV

- e) Fill out the Power Tracking Information requested.
- f) Click on the Connections Form Tab to continue.

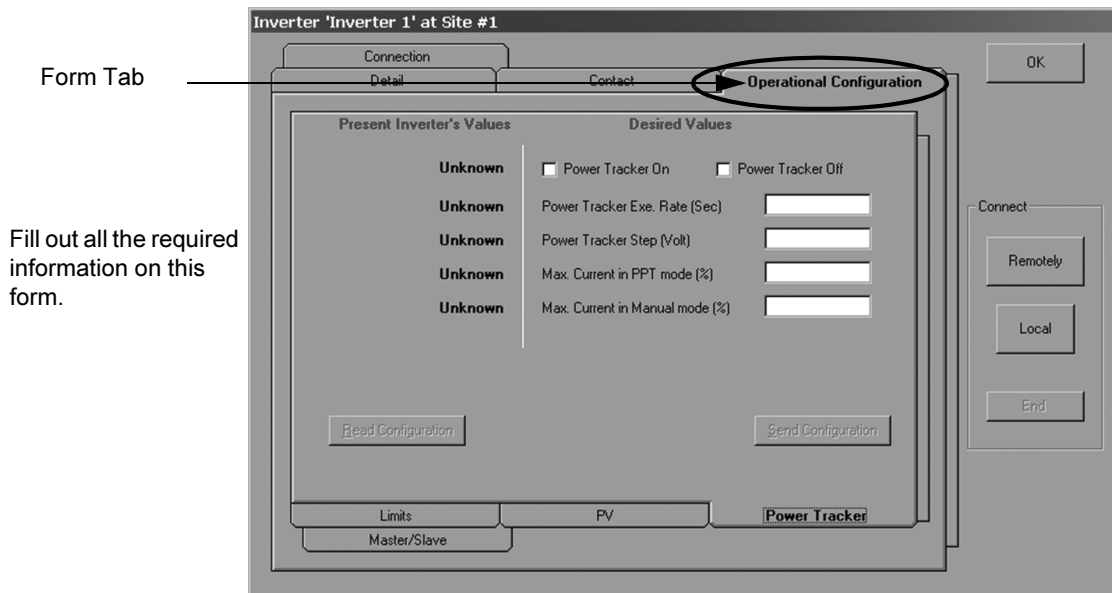

Figure 2-23 Operational Configuration Screen - Power Tracker

- 6. Fill out the **Connection - General** Information in the form in Figure 2-24.
- 7. Click on the Telephone Fault Configuration sub-menu to continue.

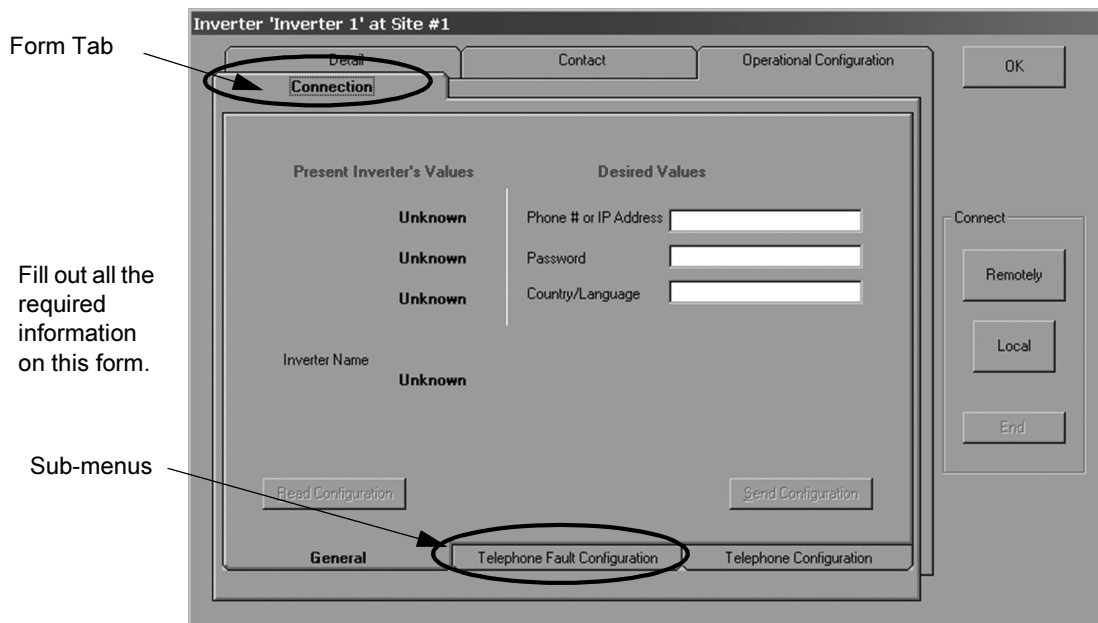

Figure 2-24 Connection Configuration Screen - General

8. Fill out the **Connection - Telephone Fault Configuration** Information in the form shown in Figure 2-25.
9. Click on the Telephone Configuration sub-menu to continue.

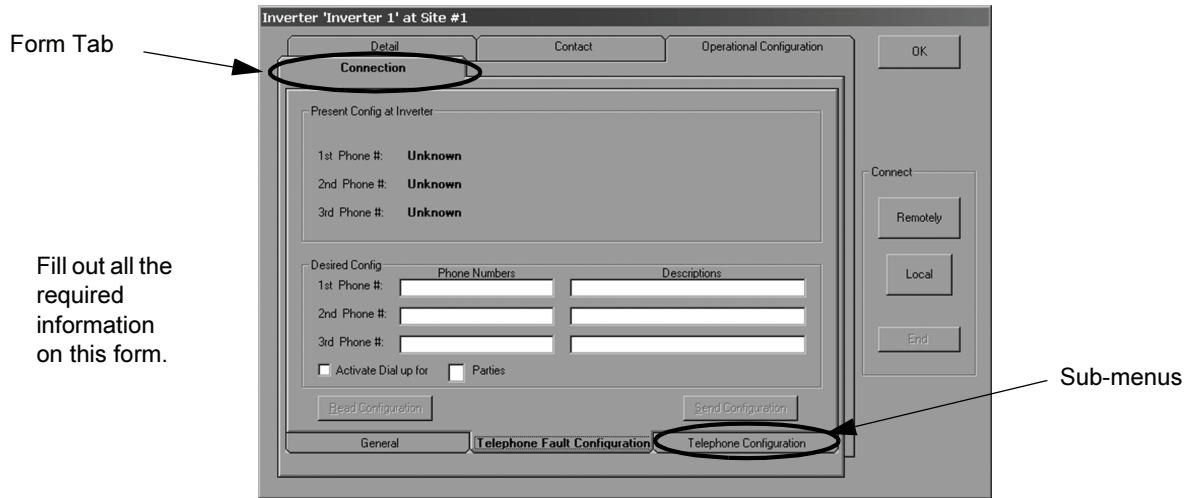

Figure 2-25 Connection Configuration Screen - Telephone Fault Configuration

10. Fill out the **Connection - Telephone Configuration** Information in the form shown in Figure 2-26.

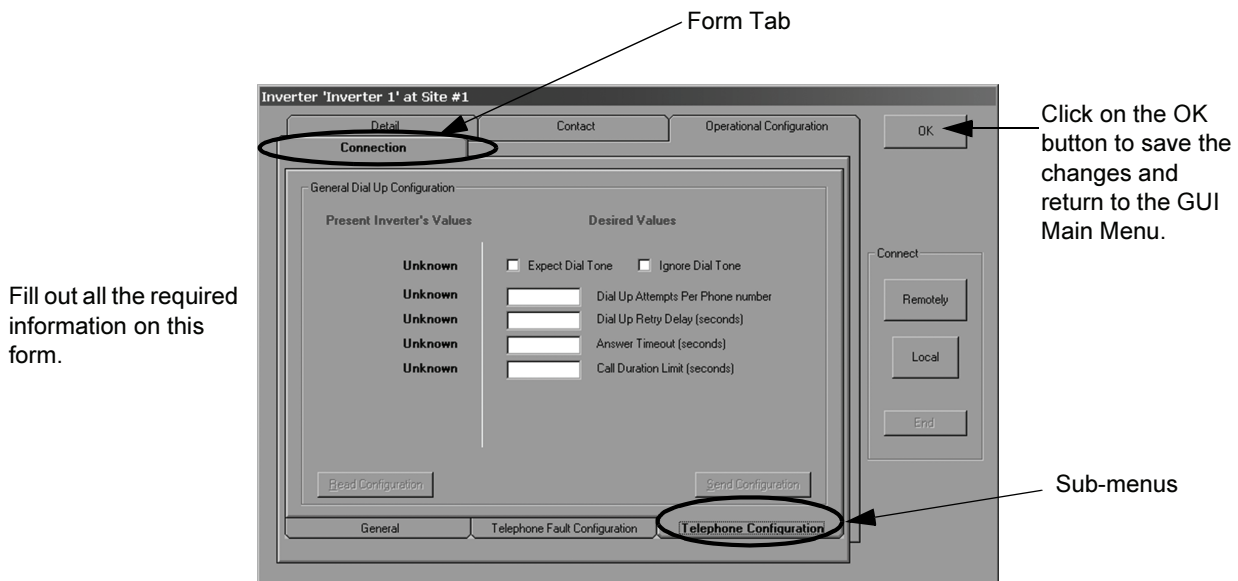

Figure 2-26 Connection Configuration Screen - General

11. Once the information is complete, click the **OK** button to accept the changes and return to the GUI main menu.

GUI Help

The GUI software program has a built-in help program. Once the program is started, click on the **HELP** menu item to start the Help program.

The Help interface is divided into the following sections.

- Getting Started - IMPORTANT: Read this first
- Setup - Tutorial for setting up the GUI and configuring an inverter
- Windows - Description of each window of the GUI
- Menu Commands - Description of each GUI Menu command
- How to... - How to perform various tasks, by topic
- Reference - Glossary and miscellaneous information
- Messages - Explanation of GUI popup messages
- Problems - Troubleshooting for problems



Figure 2-27 GUI Interface Screen if Connected Directly

3

Commissioning

Chapter 3, “Commissioning” contains information on safely commissioning the PV225S 225 kW Grid-Tied Photovoltaic Inverter.

Commissioning Procedure

This section provides the procedure necessary to safely and correctly commission a PV225S inverter.

Important: It is important to record any issues encountered while following this procedure.

Summary

To commission the PV225S:

1. Ensure the Verification Tests have been completed and have passed successfully. See the PV225S 225 kW Grid-tied Photovoltaic Inverter Planning and Installation Manual, Section 4.
2. Begin the PV225S Commissioning Procedure as described in detail further in this section. The steps are summarized below.
 - a) Start the GUI and open the PV225S Commissioning Procedure file.
 - b) Record the Serial Number.
 - c) Verify AC and DC Voltages.
 - d) Inspect Lower Inductor Enclosure.
 - e) Apply Grid Voltage.
 - f) Check the Front Panel Display.
 - g) Establish communications with the GUI.
 - h) Confirm Operational Parameters (AC, DC and Power Tracker).
 - i) Verify Door Interlock Functions.
 - j) Perform the Matrix Test.
 - k) Operate Inverter.
3. Submit the Test report and warranty form to Xantrex See “PRODUCT REGISTRATION” on page WA-3.

Starting the Commissioning Test File

1. Start the Xantrex Solar Graphical User Interface (GUI) program.
 - a) Once the application has started, select “**GENERAL PROCEDURES**” from the “**TOOLS**” pull-down menu.
 - b) In the “**SELECT FILES**” dialog box, choose “**PV225S COMMISSIONING TEST**” and click the OPEN button.
2. Verify that both the AC (S1) and DC (S2) Disconnect switches are open.
3. Verify the **ON/OFF** switch (S3) is in the **OFF** position.
4. Once you finish these tasks, go back to the GUI and click on the check box to indicate the task is complete. Go to the next step by clicking on the “**NEXT**” button.

Serial Number

1. Enter the information required by GUI in the white text boxes on the form that appears next. The converter serial number is located on a label placed on the lower-left front of the Main Inverter Enclosure door.
2. Once you finish recording the required information, click on the check box to indicate the task is complete. Go to the next step by clicking on the "NEXT" button.

Verify AC Voltage

1. Open the door of the AC Interface Enclosure and verify that the Grid AC cables have been installed at S1-2T1, S1-4T2, S1-6T3, TB11, and TB12.
2. With a voltmeter, verify if AC Grid voltage is present at the bottom of S1-2T1, S1-4T2, S1-6T3. These fuses are located in the AC Interface Enclosure.
 - a) If voltage is correct, verify phasing using a phase rotation meter. The phase rotation should be clockwise "A, B, C".
 - b) If the voltage is not present, contact the installer, site electrician or site operator to supply grid voltage to the unit.
3. If grid voltage is not available to the unit, open the AC Disconnect Switch (S1) and lock the AC Interface Enclosure. The Commissioning Test procedure must cease at this point. Do not attempt to continue the test until each step can be checked and verified.
 - a) If grid voltage is not available and the Commissioning Test must be stopped, SAVE the Commissioning File. This file will be used once grid voltage has been applied and verified.
4. Once you finish verifying AC voltages, go back to the GUI Commissioning Procedure and click on the check box to indicate the task is complete. Go to the next step by clicking on the "NEXT" button.

Verify DC Voltage

1. Open up the DC Interface Enclosure and verify that the PV DC cables have been installed correctly.
2. With a voltmeter, verify if PV DC voltage is present at S2-6 and K2-6T3.
3. Verify the correct polarity.
4. If the voltage is not present, contact the installer, site electrician or site operator to supply PV voltage to the unit.
5. If PV DC voltage is not available to the unit, open the DC Disconnect Switch (S2) and lock the DC Interface Enclosure. The Commissioning Test procedure must cease at this point. Do not attempt to continue the test until each step can be checked and verified.
 - a) If PV voltage is not available and the Commissioning Test must be stopped, SAVE the Commissioning File. This file will be used once PV DC voltage has been applied and verified.

6. Once you finish verifying PV DC voltages, go back to the GUI Commissioning Procedure and click on the check box to indicate that the task is complete. Go to the next step by clicking on the "NEXT" button.

Inspect Inductor Enclosure

1. Remove the back and side access panels to the Inductor Enclosure and inspect the connections.
2. Check for loose cables, rubbing, or interference.
3. Check the AC Sense Harness to make sure it is terminated and secured properly and not touching either inductor L3 or L4.
4. Correct and record any defects.
5. Reinstall the Inductor Enclosure access panels removed above.
6. Once you finish inspecting the Inductor Enclosure, go back to the GUI Commissioning Procedure and click on the check box to indicate the task is complete. Go to the next step by clicking on the "NEXT" button.

Apply Grid Voltage

1. Verify all enclosure doors are closed and locked.
2. Close the AC Disconnect Switch (S1). This will energize the control power circuits.
3. Look, listen and smell for signs of defects.
4. Record any defects found.
5. Once you finish applying the grid voltage, go back to the GUI Commissioning Procedure and click on the check box to indicate the task is complete. Go to the next step by clicking on the "NEXT" button.

Front Panel Display

1. Open then close the AC Disconnect Switch (S1) and look at the Front Panel. It should show the Software Versions of the CCU and Front Panel. Record these numbers. Then it should go into Initialization.
2. After about 20 seconds it will be in its "ready" mode. At this time the Fault Code "0071 PV SWITCH OPEN" will be reported. Close the PV Disconnect Switch (S2) and verify alarm 0071 clears by pressing the "F1" key on the keypad of the UFCU. If additional alarms are present, refer to Table 4-1 on page 4-4.
3. Once all faults are clear, the front panel should report Key Disable ("Switched Off") and show Inverter Status.
4. Using the \vee key, scroll down in the READ Menu and verify that the Time and Date are correct.
5. If not, refer to the "Setting the Date and Time" on page 2-21.
6. Scroll thru the parameters and verify that they are present.

7. Once you finish checking the Front Panel Display, go back to the GUI Commissioning procedure and click on the check box to indicate the task is complete. Go to the next step by clicking on the "NEXT" button.

Establish Communications with the GUI

1. Verify that the appropriate hardware has been installed for the desired communications connection—Remote or Direct Connect.
If not, refer to the “PC Connection Methods” section of the PV225S 225 kW Grid-tied Photovoltaic Inverter Planning and Installation Manual for instructions.
2. Verify that the communications with the inverter is working and that you have established a connection with the inverter through the GUI.
 - a) Verify the signal lights on the data communication devices show activity. Once communications are established, close the connection.
 - b) While at the Inverter, create a fault. This could be done by opening the DC Disconnect Switch (S2).
 - c) Verify the Inverter calls the End User and reports the fault. The fault reporting from the inverter to the End User will take approximately 1 minute.
 - d) Repair the fault—close the DC Disconnect Switch (S2)—and have the End User clear the alarm.
If communications is not working as expected, refer to the “General Troubleshooting” on page 4–2 for help.
3. Once you verify that communication has been established and is working properly, go back to the GUI Commissioning Procedure and click on the check box to indicate the task is complete. Go to the next step by clicking on the "NEXT" button.

Confirm AC Operational Parameters

1. Verify the inverter’s AC limits.
2. Make any necessary changes.
3. Record these values.
4. Once you finish these tasks, go back to the GUI Commissioning Procedure and click on the check box to indicate the task is complete. Go to the next step by clicking on the "NEXT" button.

Confirm DC Operational Parameters

1. Verify the Inverters PV Settings.
2. Make any necessary changes.
3. Record these values.
4. Once you finish these tasks, go back to the GUI Commissioning Procedure and click on the check box to indicate the task is complete. Go to the next step by clicking on the "NEXT" button.

Confirm Power Tracker Configuration Operational Parameters

1. Verify the inverter's Power Tracker Configuration.
2. Make any necessary changes.
3. Record these values.
4. Once you finish these tasks, go back to the GUI Commissioning Procedure and click on the check box to indicate the task is complete. Go to the next step by clicking on the "NEXT" button.

Verify Door Interlock Functions

1. Open the front door of the Main Inverter Enclosure and verify a door interlock fault is triggered (0070 "INTERLOCK ACTIVATED").
2. Bypass the switch by pulling it out into the service position.
3. Clear the fault.
4. Once you finish these tasks, go back to the GUI Commissioning Procedure and click on the check box to indicate the task is complete. Go to the next step by clicking on the "NEXT" button.

Matrix Test

1. Confirm that the **ON/OFF** Switch (S3) in the **OFF** position.
2. From the GUI or front panel, select Matrix test from the Goal State menu.
3. Verify the six yellow LEDs on both the left and right IGBT driver boards are blinking. The blinking yellow LEDs are an indication that the IGBT driver boards are gating correctly.
4. If any of the six yellow LEDs on either of the IGBT driver boards are not blinking, refer to the Matrix Gate Faults listed on page 4–9 of the "Left Matrix Gate" Section.
5. To stop the test, select Goal state from the GUI or Front Panel and choose Shutdown.
6. Close the door and clear any alarms.
7. Once you finish the Matrix Test, go back to the GUI Commissioning Procedure and click on the check box to indicate the task is complete. Go to the next step by clicking on the "NEXT" button.

Operate Inverter

1. Make sure all doors are closed and locked.
2. Using the Front Panel or the GUI, set the I PPT Max percent to 25%.
3. Place the **ON/OFF** Switch (S3) in the **ON** position. If the PV voltage is above PV Start voltage threshold, followed by a 5-minute delay period, the PV contactor (K2) will close, followed by the Main AC contactor (K1). The inverter will begin to produce power up to 25% of rated power.
4. Look, listen and smell for any defects.

Important: If the PV225S suddenly ceases operation, and faults with an "0014 Grid Interface Failed", this could be an indication that the power conductor terminations between the Isolation Transformer (T6-X1, T6-X2, and T6-X3) and Main Inverter Enclosure (TB5, TB6, and TB7) are incorrect. Open the AC Disconnect Switch (S1) and the DC Disconnect Switch (S2). Place the ON/OFF Switch (S3) in the OFF position. Once the System is isolated for maintenance, verify that these terminations are correct. Upon verification that the terminations are correct, close the AC and DC Disconnect Switches and repeat the previous steps.

5. Make sure the Matrix fans are operating.
6. If everything is okay, increase the I PPT Max until you reach 100%.
7. Check all the operating data with the GUI or front panel. Record any irregularities.
8. Let the inverter run.
9. Once you finish these steps, go back to the GUI Commissioning Procedure and click on the check box to indicate the task is complete. Go to the next step by clicking on the "**NEXT**" button.

Completed Commissioning

1. Once you have successfully completed all the commissioning steps, save the test report to a file.
2. Email the completed report to:
pvcommissioningreport@xantrex.com
3. Send or Fax a copy of the Product Registration Form on page WA-3 to Xantrex. The address and Fax numbers are available on page WA-3.

Thank You for choosing Xantrex "The Smart Choice for Power".

4

Troubleshooting

Chapter 4, “Troubleshooting” contains information and procedures for troubleshooting the PV225S 225 kW Grid-Tied Photovoltaic Inverter. It provides descriptions of common situations and errors that may occur and provides possible solutions for resolving fault conditions. It also provides instructions for clearing faults manually, if required.

Faults and Fault Codes

Fault states are automatic from any state of operation. In the event of a fault condition, the PV225S will immediately stop processing power and execute an immediate orderly shutdown, open both the main AC and DC contactors, and remain in a faulted state until the fault is remedied and cleared (manually or automatically).

In the event of an alarm or fault condition, the PV225S will execute an immediate, orderly shutdown and remain in a faulted state until the alarm or fault is remedied and cleared (manually or automatically).

- Faults associated with a grid disturbance clear automatically. The PV225S will automatically re-start after a 5-minute delay.
- All other faults must be cleared manually.

All fault conditions arising from within the PV225S are reported to the UFCU (Universal Frontpanel Control Unit). The 4-line LCD will display a hexadecimal value (fault code) and a brief text description of the fault.

Most faults are latching and only those faults associated with grid disturbances are auto-clearing and thus enable the PV225S to restart after a 5 minute delay period.

Once the cause of the fault has been identified and corrected, and it is determined to be safe to proceed, PV225S faults may be manually cleared from the UFCU keypad or using the remote GUI.

See “Clearing Faults Manually” on page 4–3 for instructions on this procedure.

General Troubleshooting

Respond to any PV225S alarm or fault as follows:

1. Note and document the alarm or fault code and brief text description.
2. Determine the source of the alarm or fault by referring to Table 4-1, “Fault Codes” on page 4–4.
3. Rectify the alarm or fault condition and attempt to clear the fault from the display. See “Clearing Faults Manually” on page 4–3 for instructions on this procedure.
4. If the condition is sustained and cannot be corrected, again note and document the fault code and description, and contact either your Distributor / Reseller, or Xantrex Customer Service.



WARNING: Lethal Voltage

In order to remove all sources of voltage from the PV225S, the incoming power must be de-energized at the source. This may be done at the Utility main circuit breaker, and by opening the AC disconnect and the DC disconnect switches on the PV225S. Review the system configuration to determine all of the possible sources of energy. In addition, allow 5 minutes for the DC bus capacitors, located on the ceiling of the cabinet, to discharge after removing power.

Clearing Faults Manually

Faults associated with a grid disturbance clear automatically. These faults include:

- 0010 (AC Frequency Low),
- 0011 (AC Frequency High),
- 0012 (AC Voltage Low), and
- 0013 (AC Voltage High) only.

Once the AC voltage and frequency return to within the acceptable range, the PV225S will clear the fault and automatically restart after a 5-minute delay. All other faults associated with the PV225S must be circumvented and cleared manually using the UFCU. The following procedure describes how to manually clear a fault message from the LCD.

To clear the fault:

1. Determine the source of the fault using Table 4-1, “Fault Codes” on page 4-4. Correct the fault condition.
2. Ensure the fault code and “Clear Fault?” message is displayed in the LCD.
 - a) If the “Clear Fault?” message is not shown on the second line of the LCD, scroll through the read parameter menu with the \wedge or \vee keys until the message appears.
3. To clear the fault, press **<ENTER>**. The PV225S will transition to Sleeping mode.

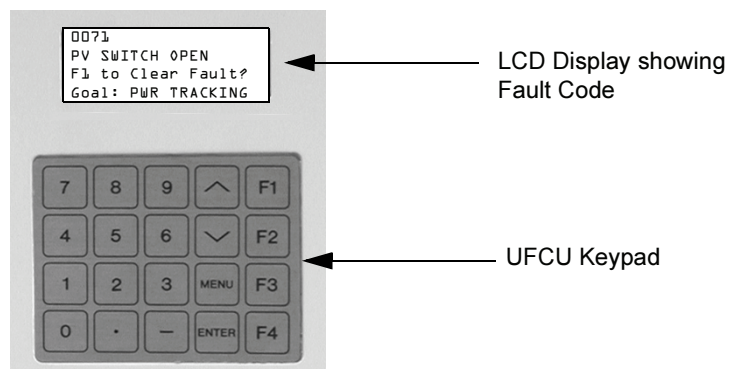

Figure 4-1 LCD showing Fault Code

Important:: If the fault does not clear, the fault condition has not been corrected.

Fault Code Descriptions

Table 4-1 provides a complete description of all the fault conditions that may occur on the PV225S.

Table 4-1 Fault Codes

Error Code	Fault Source(s)	Fault Type H=Hardware S=Software	Fault Description	Possible Causes
0000	No Faults	N/A	N/A	N/A
0010	AC Frequency Low	S	This fault indicates that the Utility grid frequency is below or fell below the minimum allowed value of 59.3 Hz for greater than 6 cycles. This fault is auto-clearing. Once the Utility grid frequency has recovered within the acceptable operating range, the PV225S will qualify the value and automatically clear this fault and resume normal operation after 5 minute delay period.	<ul style="list-style-type: none"> Utility grid frequency fell below the allowable limit
0011	AC Frequency High	S	This fault indicates that the Utility grid frequency is above or rose above the maximum allowed value of 60.5Hz for greater than 6 cycles. This fault is auto-clearing. Once the Utility grid frequency has recovered within the acceptable operating range, the PV225S will qualify the value and automatically clear this fault and resume normal operation after 5 minute delay period.	<ul style="list-style-type: none"> Utility grid frequency rose above the allowable limit
0012	AC Voltage Low	S	This fault indicates that the utility grid voltage is below or fell below the minimum allowed value of 88% of nominal Vac for greater than 2 seconds, or 50% of nominal VAC for greater than 6 cycles. This fault is auto-clearing. Once the Utility grid voltage has recovered within the acceptable operating range, the PV225S will qualify the value and automatically clear this fault and resume normal operation after 5 minute delay period.	<ul style="list-style-type: none"> Utility grid voltage fell below the allowable limit Fuses F1, F2, F3, F7, F8 or F9 blown P1001 on CCU2 is loose or disconnected

Table 4-1 Fault Codes

Error Code	Fault Source(s)	Fault Type H=Hardware S=Software	Fault Description	Possible Causes
0013	AC Voltage High	S	This fault indicates that the utility grid voltage is above or rose above the maximum allowed value of 110% of nominal Vac for greater than 2 seconds, or 137% of nominal Vac for greater than 2 cycles. This fault is auto-clearing. Once the Utility grid voltage has recovered within the acceptable operating range, the PV225S will qualify the value and automatically clear this fault and resume normal operation after 5 minute delay period.	<ul style="list-style-type: none"> Utility grid voltage rose above the allowable limit
0014	Grid Interface Failed	S	This fault indicates that the PV225S has detected an imbalance of AC output power of 5kW or greater when compared to the DC input power for more than 6 seconds. This normally means that the connection of the PV225S to the grid has failed.	<ul style="list-style-type: none"> K1 was opened while the PV225S was processing power K1 is inoperable K3 is inoperable SSR1 is inoperable TS1 or TS2 is open
0015	Grid Disconnection	S	This fault indicates that the PV225S has detected a sudden AC voltage increase of greater than 40% of the nominal peak-to-peak value. This normally is the result of a sudden disconnection from the Utility grid while the PV225S was processing power.	<ul style="list-style-type: none"> S1 was opened while the PV225S was processing power
0016	DC Contactor Circuit	S	This fault indicates that upon entering the Power Tracking State, the PV225S has detected that the PV voltage has remained above the PV Start Voltage threshold even after commanding the DC contactor to close. This condition is indicative of a DC contactor circuit failure.	<ul style="list-style-type: none"> K2 is inoperable SSR2 is inoperable TS1 or TS2 is open

Table 4-1 Fault Codes

Error Code	Fault Source(s)	Fault Type H=Hardware S=Software	Fault Description	Possible Causes
0017	Phase Error	S	This fault indicates that the PV225S has detected an incorrect phase rotation of the incoming AC grid voltage. This condition is indicative of a power conductor termination error, resulting in improper phasing sequence.	<ul style="list-style-type: none"> AC power conductors terminated at S1-2T1, S1-4T2, and S1-6T3 are improperly phased.
0020	PV Over-Current	S	This fault indicates that the PV225S has detected a DC current greater than the maximum allowed value of 900 A DC.	<ul style="list-style-type: none"> CT7 is inoperable CCU2 ± 15 Vdc Power Supply is defective P3 on CCU2 is loose or disconnected PV system wiring short
0021	PV Over-Voltage	S	This fault indicates that the PV225S has detected a DC input voltage of greater than the maximum allowed value of 600 Vdc.	<ul style="list-style-type: none"> PV system wiring short Lightning strike on PV system wiring
0023	Bus Voltage High	H	This fault indicates that the PV225S has detected that the DC bus voltage has exceeded the maximum allowed value of 925 Vdc.	<ul style="list-style-type: none"> PV system wiring short Lightning strike on PV system wiring
XX31	Left Matrix Over Current	S	<p>This fault indicates that the PV225S has detected that the AC current on one or more phases of the inverter output has exceeded the maximum allowed value of 712 A_{rms}.</p> <p>The first two digits of the fault code indicate the particular phase where the over current occurred as follow:</p> <ul style="list-style-type: none"> 0131 - Matrix over current in phase A 0231 - Matrix over current in phase B 0431 - Matrix over current in phase C <p>If more than one phase faults simultaneously, the two first digits are added in hexadecimal form to indicate an over current condition in more than one phase, thus the error code will contain the summation of the faulted phases.</p>	<ul style="list-style-type: none"> CT1, CT2, or CT3 are inoperable CCU2 ± 15 Vdc Power Supply is defective P3 on CCU2 is loose or disconnected AC system wiring short

Table 4-1 Fault Codes

Error Code	Fault Source(s)	Fault Type H=Hardware S=Software	Fault Description	Possible Causes
XX32	Right Matrix Over Current	S	<p>This fault indicates that the PV225S has detected that the AC current on one or more phases of the inverter output has exceeded the maximum allowed value of 712 A_{rms}.</p> <p>The first two digits of the fault code indicate the particular phase where the over current occurred as follow:</p> <ul style="list-style-type: none"> • 0132 - Matrix over current in phase A • 0232 - Matrix over current in phase B • 0432 - Matrix over current in phase C <p>If more than one phase faults simultaneously, the two first digits are added in hexadecimal form to indicate an over current condition in more than one phase, thus the error code will contain the summation of the faulted phases.</p>	<ul style="list-style-type: none"> • CT4, CT5, or CT6 are inoperable • CCU2 ±15Vdc Power Supply is defective • P3 on CCU2 is loose or disconnected • AC system wiring short
0033	Ground Over Current	S	<p>This fault indicates that the PV225S has detected that the ground fault current has exceeded the maximum allowed value. This maximum allowed value for ground fault current is a user-configurable setting with a range of 1 to 20 Adc. The default setting for this value is 10 Adc.</p>	<ul style="list-style-type: none"> • CT8 is inoperable • CCU2 ±15 Vdc Power Supply is defective • P3 on CCU2 is loose or disconnected • Ground -to-AC or DC-to-System wiring short
0040	Programming Software	S	<p>This code indicates that the PV225S has detected that the system is in Programming mode. This fault does not indicate any malfunction with the PV225S, but is merely an indication that the system software is in the process of being downloaded into the EEPROMs of the CCU2.</p>	

Table 4-1 Fault Codes

Error Code	Fault Source(s)	Fault Type H=Hardware S=Software	Fault Description	Possible Causes
0041	State Invalid	S	The state machine implemented within the CCU2 system software governs the operation of the PV225S. This fault indicates that the PV225S has detected an unknown system variable and has encountered an invalid state.	<ul style="list-style-type: none"> • Internal RAM error • CPU error
0042	Serial EEPROM Write Error	S	This fault indicates that the PV225S has detected a serial EEPROM write error. The CCU2 controller board performs a verification check of data written to ROM compared to what is read back.	<ul style="list-style-type: none"> • Internal ROM error • CPU error
0043	Serial EEPROM Timeout	S	This fault indicates that the PV225S has detected that when writing data to the serial EEPROM, a confirmation timer of 300mS has expired.	<ul style="list-style-type: none"> • Internal ROM error • CPU error
0044	Bad NOVRAM Memory	S	This fault indicates that the PV225S has detected that one of the two non-volatile memory banks on the CCU2 controller board has failed. The CCU2 performs a series of tests to confirm the validity of the NOVRAM, and one of the two banks has produced errors.	<ul style="list-style-type: none"> • Internal NOVRAM error • CPU error
0045	Interrupt 2 Timeout	S	This fault indicates that the PV225S has detected that an interrupt 2 timeout has occurred. The CCU2 controller board performs a conversion validation of analog-to-digital data within the A to D converters. If validation of the conversion is not performed within 500mS, an interrupt 2 timeout fault will occur.	<ul style="list-style-type: none"> • Internal A to D converter error • CPU error
0047	Software Test	S	This fault indicates that the PV225S has detected that a software test fault has occurred. This is a simulated fault used for debugging purposes.	

Table 4-1 Fault Codes

Error Code	Fault Source(s)	Fault Type H=Hardware S=Software	Fault Description	Possible Causes
0048	Bad Memory	S	This fault indicates that the PV225S has detected that the SRAM DIMM on the CCU2 controller board has failed. The CCU2 performs a series of tests to confirm the validity of the SRAM and the memory module has produced errors.	<ul style="list-style-type: none"> • Internal SRAM error • CPU error
XX50	Left Matrix Gate	S	<p>The CCU2 controller sends digitized timing signals for gating the IGBT's via the IPM driver board and bi-directional fiber optic communication. This fault indicates that the PV225S has detected that an IGBT gate drive fault has occurred in the left matrix. An internal protection circuit within the individual IPM devices of the IGBT matrix also generates a gate fault as the result of either short circuit, over current, over temperature, or an under voltage condition.</p> <p>The first two digits of the fault code indicate the particular IGBT that reported the fault, as follows:</p> <ul style="list-style-type: none"> • 0150 (A+) • 0250 (A-) • 0450 (B+) • 0850 (B-) • 1050 (C+) • 2050 (C-) <p>If more than one IGBT faults simultaneously, the two first digits are added in hexadecimal form to indicate that the gate drive fault has occurred in more than one phase, thus the error code will contain the summation of the faulted phases.</p>	<ul style="list-style-type: none"> • Fiber-optic harness is loose or disconnected • PS1 ±15 Vdc Power Supply is defective • P1 on IPM driver board is loose or disconnected • IPM internal error condition

Table 4-1 Fault Codes

Error Code	Fault Source(s)	Fault Type H=Hardware S=Software	Fault Description	Possible Causes
XX51	Right Matrix Gate	S	<p>The CCU2 controller sends digitized timing signals for gating the IGBT's via the IPM driver board and bi-directional fiber optic communication. This fault indicates that the PV225S has detected that an IGBT gate drive fault has occurred in the right matrix. An internal protection circuit within the individual IPM devices of the IGBT matrix also generates a gate fault as the result of either short circuit, over current, over temperature, or an under voltage condition.</p> <p>The first two digits of the fault code indicate the particular IGBT that reported the fault, as follows:</p> <ul style="list-style-type: none"> • 0151 (A+) • 0251 (A-) • 0451 (B+) • 0851 (B-) • 1051 (C+) • 2051 (C-) <p>If more than one IGBT faults simultaneously, the two first digits are added in hexadecimal form to indicate that the gate drive fault has occurred in more than one phase, thus the error code will contain the summation of the faulted phases.</p>	<ul style="list-style-type: none"> • Fiber-optic harness is loose or disconnected • PS1 ±15 Vdc Power Supply is defective • P1 on IPM driver board is loose or disconnected • IPM internal error condition
XX60	Left Matrix Temperature	S	<p>This fault indicates that the PV225S has detected that the temperature of the left IGBT matrix aluminum heatsink has exceeded the maximum allowed value of 95 °C.</p>	<ul style="list-style-type: none"> • Fuses F15 or F16 blown • External cooling fan inoperable • Air flow on heat sink impeded due to accumulation of debris • Operation above rated ambient temperature for an extended period of time

Table 4-1 Fault Codes

Error Code	Fault Source(s)	Fault Type H=Hardware S=Software	Fault Description	Possible Causes
XX61	Right Matrix Temperature	S	This fault indicates that the PV225S has detected that the temperature of the right IGBT matrix aluminum heatsink has exceeded the maximum allowed value of 95 °C.	<ul style="list-style-type: none"> • Fuses F15 or F16 blown • External cooling fan inoperable • Air flow on heat sink impeded due to accumulation of debris • Operation above rated ambient temperature for an extended period of time
0070	Interlock Activated	H	This fault indicates that the PV225S has detected that the door of the Main Inverter Enclosure is open and the door interlock switch is in the active position. This fault is primarily for personnel safety. Opening the door of the Main Inverter Enclosure while the PV225S is processing power will cause an immediate orderly shutdown of the system.	<ul style="list-style-type: none"> • Door is open and interlock switch is active • Interlock switch is inoperable • P2 or P3 on CCU2 is loose or disconnected • CCU2 ±15Vdc Power Supply is defective
0071	PV Switch Open	H	This fault indicates that the PV225S has detected that the DC Disconnect Switch (S2) is open and the auxiliary switch is in the active position. This fault is primarily for personnel safety. Opening the DC disconnect switch while the PV225S is processing power will cause an immediate orderly shutdown of the system.	<ul style="list-style-type: none"> • DC disconnect switch is open and auxiliary switch is active • Auxiliary switch is inoperable • P2 or P3 on CCU2 is loose or disconnected • CCU2 ±15 Vdc Power Supply is defective
0075	Shutdown Remotely	S	This fault indicates that the PV225S has detected that the system was commanded via the GUI to transition to the Shutdown State. This fault is not indicative of a failure or malfunction, but primarily used to disable the system remotely.	<ul style="list-style-type: none"> • Remote Shutdown command via the GUI

Table 4-1 Fault Codes

Error Code	Fault Source(s)	Fault Type H=Hardware S=Software	Fault Description	Possible Causes
0080	Left Matrix Not ON	S	This fault indicates that the PV225S has detected that the left IGBT matrix (FPGA) was not enabled after having sent a command for it to turn on. The CCU2 sends an acknowledge bit to confirm the command is received. This fault is primarily a watch-dog between software and hardware to ensure control of the left IGBT matrix (FPGA).	<ul style="list-style-type: none"> • Software acknowledge bit not accepted • FPGA inoperable
0081	Right Matrix Not ON	S	This fault indicates that the PV225S has detected that the right IGBT matrix (FPGA) was not enabled after having sent a command for it to turn on. The CCU2 sends an acknowledge bit to confirm the command is received. This fault is primarily a watch-dog between software and hardware to ensure control of the right IGBT matrix (FPGA).	<ul style="list-style-type: none"> • Software acknowledge bit not accepted • FPGA inoperable
0084	Left Matrix Not OFF	S	This fault indicates that the PV225S has detected that the left IGBT matrix (FPGA) was not disabled after having sent a command for it to turn off. The CCU2 sends an acknowledge bit to confirm the command is received. This fault is primarily a watch-dog between software and hardware to ensure control of the left IGBT matrix (FPGA).	<ul style="list-style-type: none"> • Software acknowledge bit not accepted • FPGA inoperable
0085	Right Matrix Not OFF	S	This fault indicates that the PV225S has detected that the right IGBT matrix (FPGA) was not disabled after having sent a command for it to turn off. The CCU2 sends an acknowledge bit to confirm the command is received. This fault is primarily a watch-dog between software and hardware to ensure control of the right IGBT matrix (FPGA).	<ul style="list-style-type: none"> • Software acknowledge bit not accepted • FPGA inoperable

Table 4-1 Fault Codes

Error Code	Fault Source(s)	Fault Type H=Hardware S=Software	Fault Description	Possible Causes
F000	Shipping Software	S	This fault indicates that the PV225S has detected that the CCU2 controller board has shipping software installed. This software is not operational software. The correct system software for the PV225S must be downloaded into the CCU2 controller board.	
F100	Software Restarted	S	This fault indicates that the PV225S has detected that the system software has been re-booted. This is not a true fault, and does not effect the operation of the PV225S. It is primarily used as a watchdog for debugging purposes.	

5

Preventative Maintenance

Chapter 5, “Preventative Maintenance” contains information and procedures for performing preventative maintenance on the PV225S 225 kW Grid-Tied Photovoltaic Inverter.

Maintenance Safety

Prior to following any Maintenance Procedures, follow the System Shutdown and Lock-out and Tag procedure.

Operational Safety Procedures

Never work alone when servicing this equipment. A team of two is required until the equipment is properly de-energized, locked-out and tagged, and verified de-energized with a meter. Thoroughly inspect the equipment prior to energizing. Verify that no tools or equipment have inadvertently been left behind.



WARNING: Shock Hazard

Review the system schematic for the installation to verify that all available energy sources are de-energized. DC bus voltage may also be present. Be sure to wait the full 5 minutes to allow the capacitors to discharge completely.

De-Energize/Isolation Procedure

The following procedure should be followed to de-energize the PV225S for maintenance:



WARNING: Shock Hazard

The terminals of the DC input may be energized if the PV arrays are energized. In addition, allow 5 minutes for all capacitors within the main enclosure to discharge after disconnecting the PV225S from AC and DC sources.

To isolate the PV225S:

1. Turn the ON/OFF switch to the OFF position.
2. Open the DC Disconnect Switch.
3. Open the AC Disconnect Switch.
4. Open the utility connection circuit breaker.
5. Install lockout devices on the utility connection circuit breaker and DC Disconnect Switch.

Lockout and Tag

Safety requirements mandate that this equipment not be serviced while energized. Power sources for the PV225S must be locked-out and tagged prior to servicing. Each energy source should have a padlock and tag installed on each energy source prior to servicing.



WARNING: Shock Hazard

Review the system schematic for the installation to verify that all available energy sources are de-energized. DC bus voltage may also be present. Be sure to wait the full 5 minutes to allow the capacitors to discharge completely.

The PV225S can be energized from both the AC source and the DC source. To ensure that the inverter is de-energized prior to servicing, lock out and tag the PV225S using the following procedure.

1. Open, lockout, and tag the incoming power at the utility main circuit breaker.
2. Open, lockout, and tag the AC Disconnect Switch (S1) on AC interface assembly. See Figure 1-8 on page 1–12 for the location of the AC Disconnect Switch.
3. Open, lockout, and tag the DC Disconnect Switch (S2) on DC interface assembly. See Figure 1-8 on page 1–12 for the location of the DC Disconnect Switch.
4. Using a confirmed, accurate meter, verify all power to the inverter is de-energized. A confirmed, accurate meter must be verified on a known voltage before use. Ensure that all incoming energy sources are de-energized by checking the following locations.
 - a) *Inverter Terminals*: **TB5, TB6, and TB7** (Phase A, B, C)
See Figure 5-1 on page 5–4.
 - b) *Utility Terminals*: **Top of S1-2T1, S1-4T2, and S1-6T3**
See Figure 5-2 on page 5–4.
 - c) *PV Terminals*: **Bottom of S2-6, K2-6T3, and TB4** (PV+, PV-, GND)
See Figure 5-3 on page 5–5.

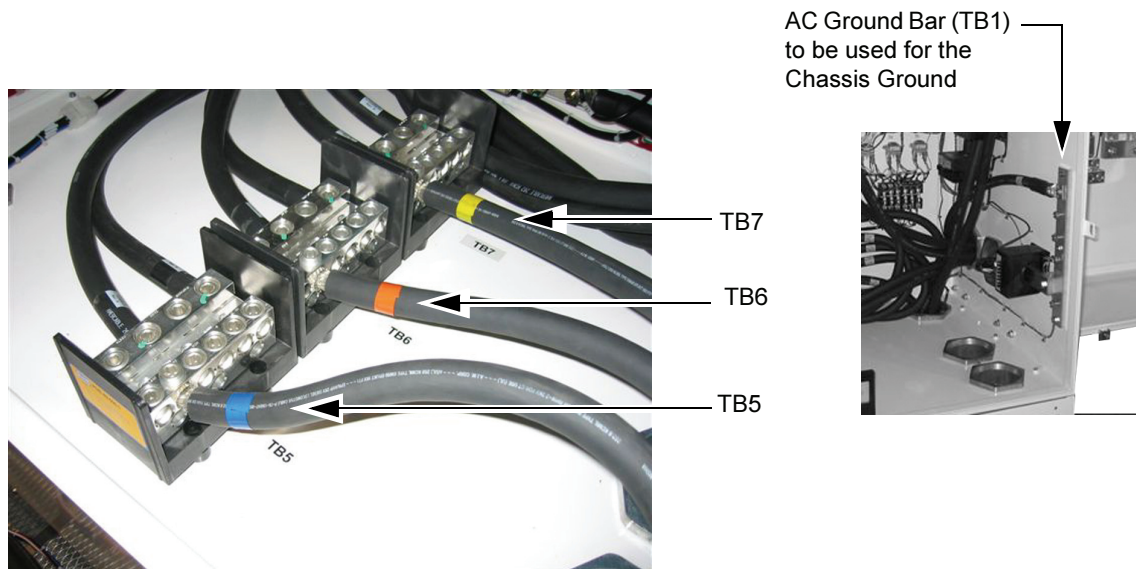

Figure 5-1 Inverter AC Terminal Locations in the Main Inverter Enclosure

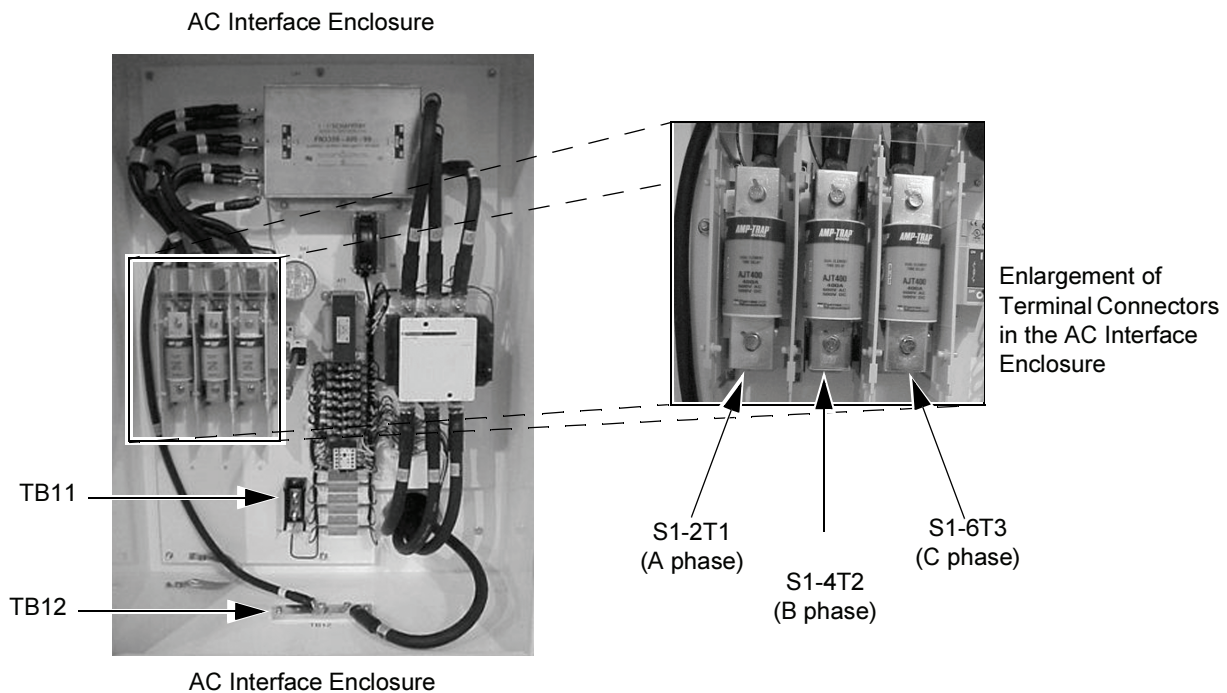

Figure 5-2 Utility AC Terminal Connections in the AC Interface Enclosure

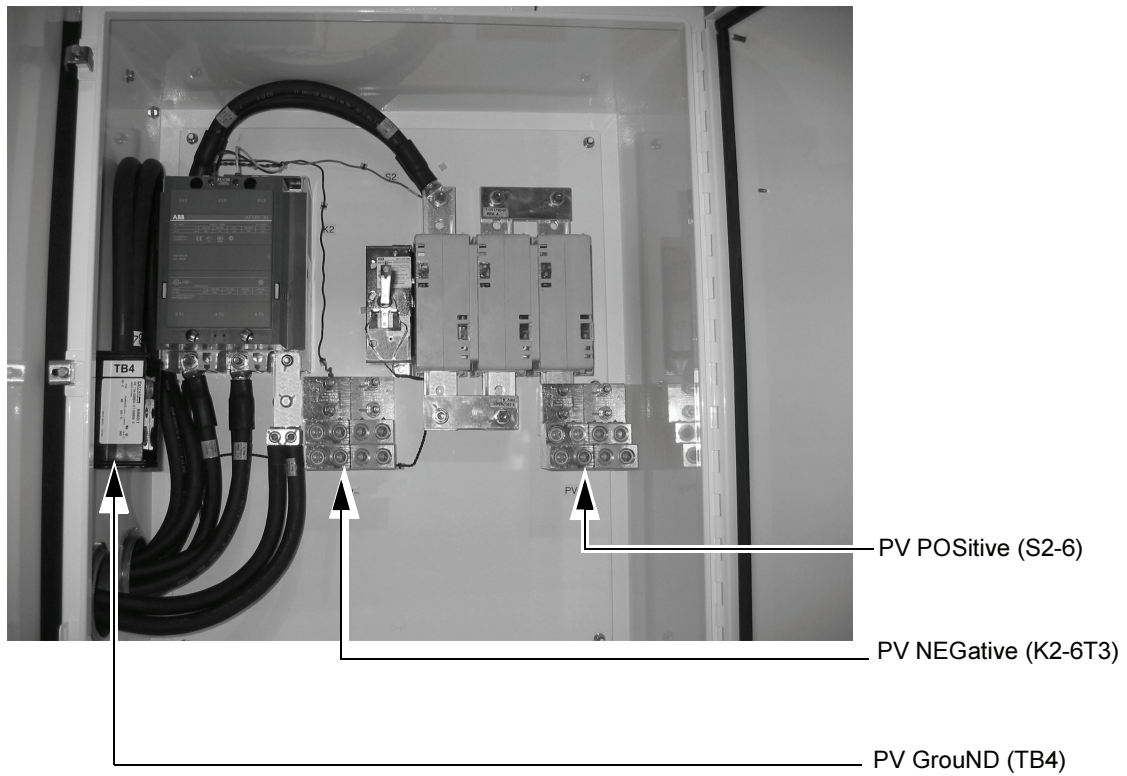

Figure 5-3 PV Terminal Locations

Periodic Maintenance

Xantrex Technology recommends that the following preventative maintenance procedures be carried out on the PV225S.

Monthly Intervals or As Required

Perform the following preventative maintenance tasks on a monthly basis or as required.

Aluminum Extrusion Heatsinks

- Inspect the aluminum extrusion heatsinks and external cooling fans for accumulation of dirt and debris. Accumulation of dirt and debris on the aluminum extrusion heatsinks and external cooling fans will decrease their ability to transfer heat, which may cause the PV225S to enter a fault state based upon an over-temperature alarm. Remove and clean if debris is present.

Fan Operation

- Verify proper operation of the external cooling fans (B1 and B2) located above the matrix aluminum extrusion heatsinks. These fans operate when the K1 contactor is closed. If present, remove any debris from the fans.

Internal Circulation Fan

- Verify the internal circulation fan (B3) is operating whenever there is utility power applied to the PV225S.

Inductor Enclosure Cooling Fans

- Verify that the inductor enclosure cooling fans (B4 and B5) operate whenever the PV225S is processing power. The airflow direction should be from the outside, forcing air into the enclosure. If present, remove any debris from the fans.

Six-month Intervals

Perform the following preventative maintenance tasks on a six-month basis or as required.

Enclosure Seals

- ❑ Inspect the enclosure access panel seal. If damaged, replace with equivalent closed cell foam gasket. Call your Xantrex Technology distributor for factory replacements or specifications.

Electrical Connections

- ❑ Inspect the condition of all wiring within and interfacing to the PV225S.
- ❑ Inspect all compression-type cable terminations and box-type connections within the AC and DC Interface Enclosures, Main Inverter Enclosure, and Transformer Enclosure for damage caused from high temperature.
- ❑ Also check these terminations and connections for signs of corrosion. If any cabling or wiring within and interfacing to the PV225S are found to be or are suspected to be unacceptable, contact your Xantrex Technology distributor for factory replacements or recommendations. Replacement of any damaged wires will be necessary.
- ❑ Verify all mechanical connections are sufficiently tightened. Verify all conduction surfaces are clean and free of corrosion. Mechanical electrical connections may loosen over time primarily due to thermal cycling during normal operation. As electrical connections loosen, impedance will increase at the connection, eventually leading to possible fire and component damage. It is critical to check all electrical connections every six months.

See termination torque specifications for AC connections in Table A-4 on page A-4. See termination torque specifications for DC connections in Table A-5 on page A-4.

Inductor Enclosure

- ❑ Remove the access panels on the inductor enclosure and inspect for any accumulated dirt and debris within the enclosure. Vacuum enclosure whenever dust or dirt is present.

A

Specifications

Appendix A provides the environmental and electrical specifications for the PV225S 225 kW Grid-Tied Photovoltaic Inverter.

System Specifications

The PV225S has been designed for photovoltaic power systems, which operate within the following specifications.



CAUTION: Equipment Damage

Operation of the PV225S in a manner other than specified in this manual may cause damage to the PV225S and other system components and will void the terms of the warranty.

Environmental Specifications

The following environmental specifications are the same for both models of the PV225S 225 kW Grid-Tied Photovoltaic Inverter.

Table A-1 Environmental Specifications

Specification	Value
Dimensions	
Inverter and DC Interface	88.5 in H x 80 in W x 32 in D (225 cm H x 203 cm W x 81 cm)
Transformer and AC Interface	49.5 in H x 61.5 in W x 35.5 in D (126 cm H x 156 cm W x 90 cm D)
Overall System Footprint:	
Layout Option A	14 ft W x 5 ft L (approximate) (4.3 m x 1.5 m)
Layout Option B	10 ft W x 9 ft L (approximate) (3 m W x 2.7 m L)
Weight	
Inverter and DC Interface	2300 lbs (approximate)
Transformer and AC Interface	2350 lbs (approximate)
Overall Weight	4650 lbs (approximate)
Allowable Ambient Temperature	
Operating	-20 °C to 50 °C Maximum
Storage	-40 °C to 50 °C Maximum
Relative Humidity	To 95%, Non-condensing
Elevation	Power Derated above 6600 ft
Clearance (ventilation and serviceability)	<i>In front of access doors: 36 in (91 cm)</i> <i>In front of access panels: 36 in (91 cm)</i> <i>Sides: 12 in (30 cm)</i> <i>Back: 6 in (15 cm)</i>
Maximum Distance between Main Inverter Enclosure and AC Interface/Transformer Enclosure	15 ft (4.5 m)

Electrical Specifications

Table A-2 provides the AC and DC specifications for the PV225S.

Table A-2 Electrical Specifications

Specification	PV225S-480-P
Nominal AC Input Voltage (+10% to -12% acceptable range)	480 Vac (422 to 528 Vac)
Maximum AC Output Current	271 A _{rms}
Nominal AC Input Frequency (+0.5 to -0.7 Hz acceptable range)	60 Hz (59.3 to 60.5 Hz)
Output Power	225 kW
Peak Power Tracking Window	300 to 600 Vdc
Maximum Open Circuit Voltage	600 Vdc
Maximum DC Input Current	781 amps

Over Voltage, Under Voltage and Frequency Ranges

Table A-3 provides the over voltage, under voltage, over-frequency, and under-frequency detection limits for the PV225S. These detection limits have been factory tested and deemed to be in compliance with IEEE-292 and UL 1741 requirements for utility interaction.

Table A-3 Over/Under Voltage and Over/Under Frequency Ranges

Vac Condition (% of Nominal)	PV225S-480-P	
	Voltage Range	Trip Time
Vac < 50%	Vac < 240	6 cycles
50% ≤ Vac < 88%	240 ≤ Vac < 422	2 seconds
88% < Vac ≤ 110%	422 < Vac ≤ 528	normal operation
110% < Vac < 137%	528 < Vac < 657	2 seconds
137% ≤ Vac	657 ≤ Vac	2 cycles
f < rated -0.7	f < 59.3	6 cycles
f > rated +0.5	f > 60.5	6 cycles

Wire Gauge and Torque Requirements

Table A-4 provides acceptable wire gauges, bolt sizes, and torque values for AC terminal connections.

Table A-4 AC Terminal Wire Gauge, Bolt Size, and Torque Values

AC Terminal Connections	Acceptable Wire Size Range (both models)	Bolt (Hardware) Size	Torque Requirements
TB1 (Chassis Ground)	500 MCM to #4 AWG (1 stud per pole)	3/8-16	420 in-lb (47.5 Nm)
TB12 (System Ground)	500 MCM to #4 AWG (1 stud per pole)	3/8-16	420 in-lb (47.5 Nm)
TB11 (Neutral)	500 MCM to #4 AWG (1 stud per pole)	3/8-16	228 in-lb (25.7 Nm)
S1-2T1, S1-4T2, S1-6T3	350 MCM to #6 AWG (1 stud per phase)	M10	310 in-lb (35.0 Nm)
T6-X1, T6-X2, T6- X3	350 MCM to #6 AWG (2 stud per phase)	3/8-16	420 in-lb (47.45 Nm)
TB5, TB6, TB7	350 MCM to #4 AWG (6 openings per phase)	3/8 Hex	375 in-lb (42.4 Nm)

Table A-5 provides acceptable wire gauges, bolt sizes, and torque values to be connected to the PV225S DC terminal connections.

Table A-5 DC Terminal Wire Gauge, Bolt Size, and Torque Values

DC Terminal Connections	Acceptable Wire Size Range (both models)	Bolt (Hardware) Size	Torque Requirements
S2-6, K2-6T3, TB4	600 MCM to #4 AWG (2 openings per pole)	1/2 Hex	600 in-lb (67.8 Nm)

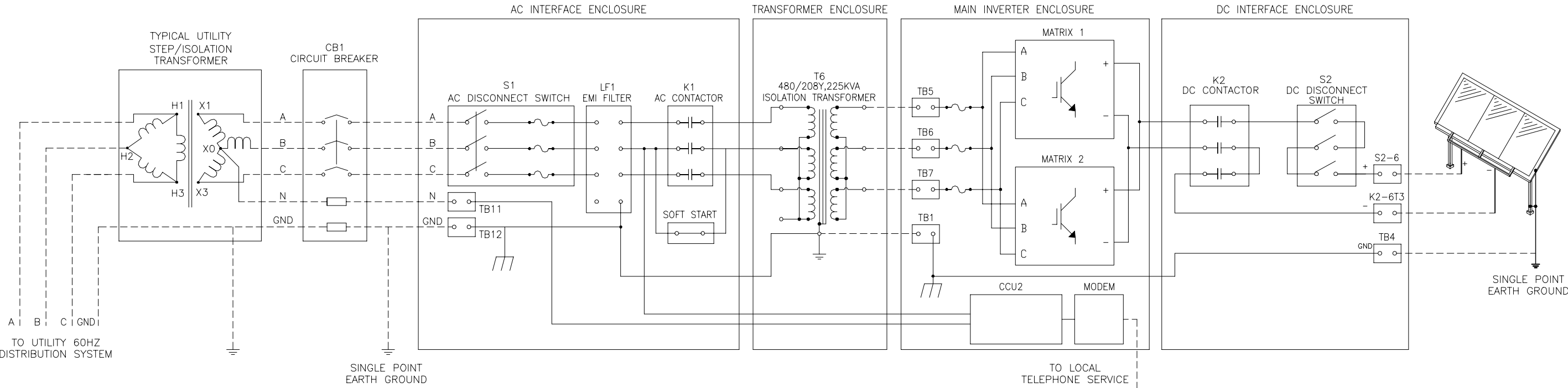

Figure A-1 Electrical Diagram (sample)

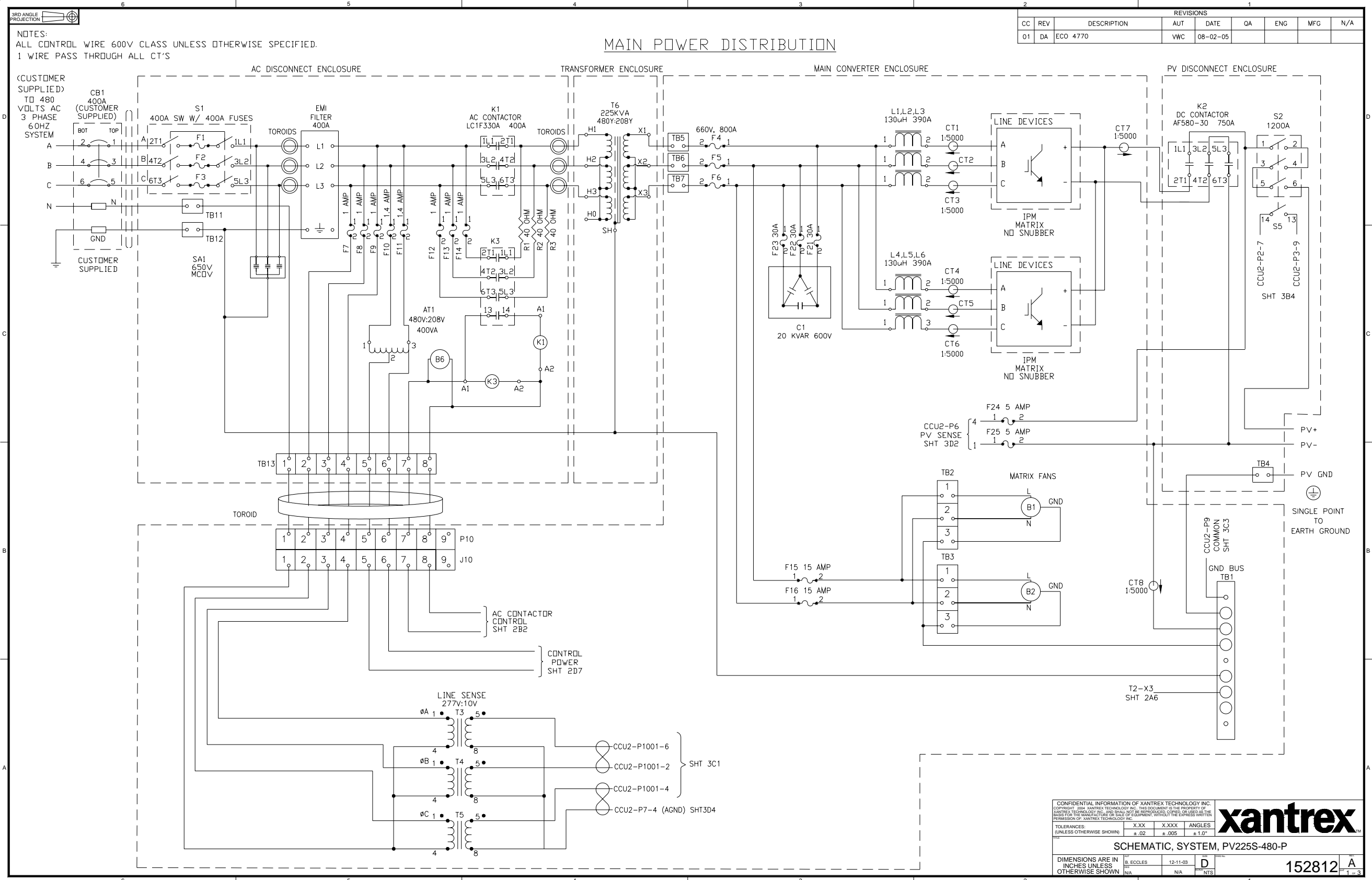

Figure A-2 PV225S Schematic for Main Power Distribution (152812 A1)

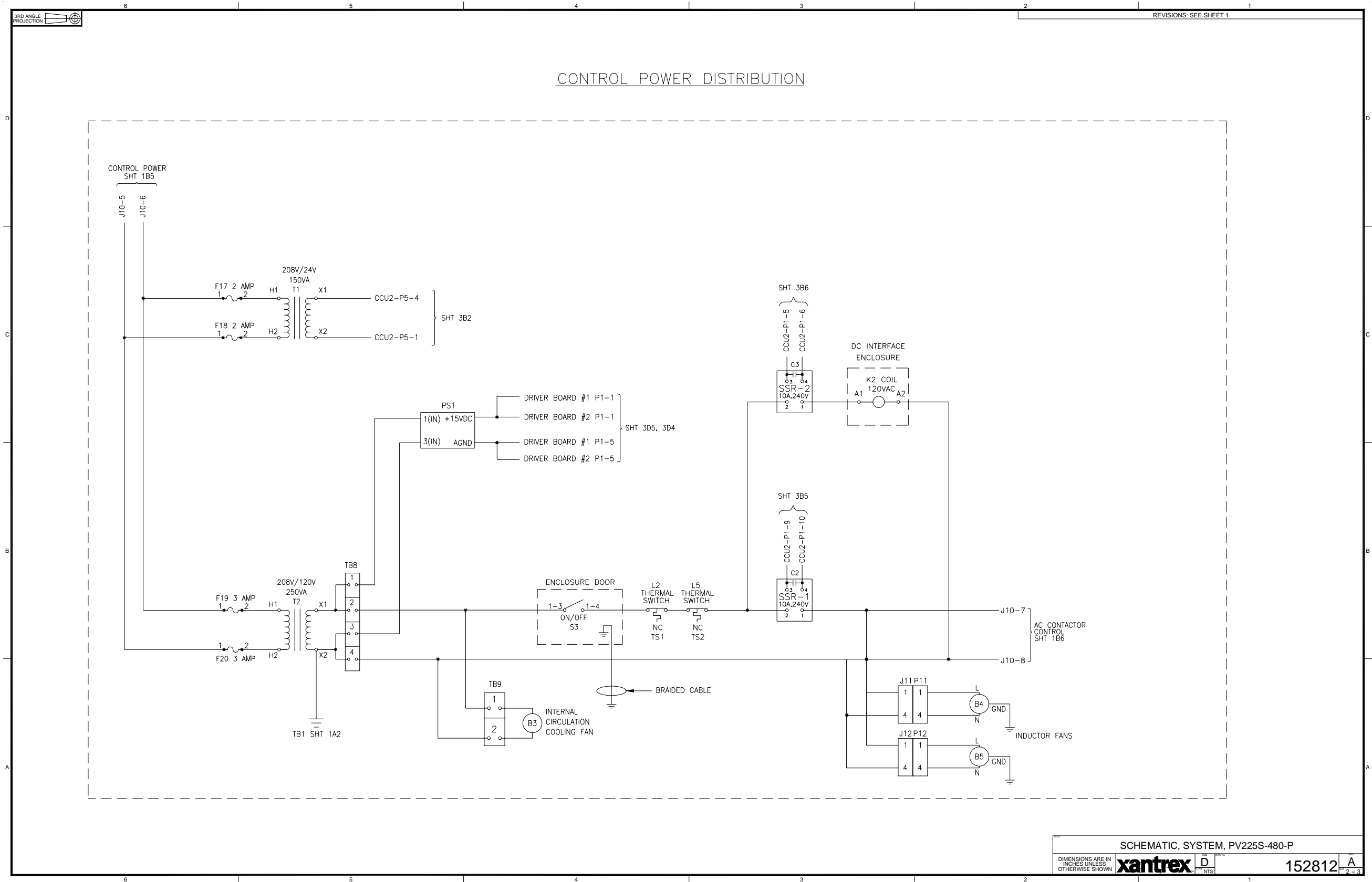

Figure A-3 PV225S Schematic for Control Power Distribution (152812 A2)

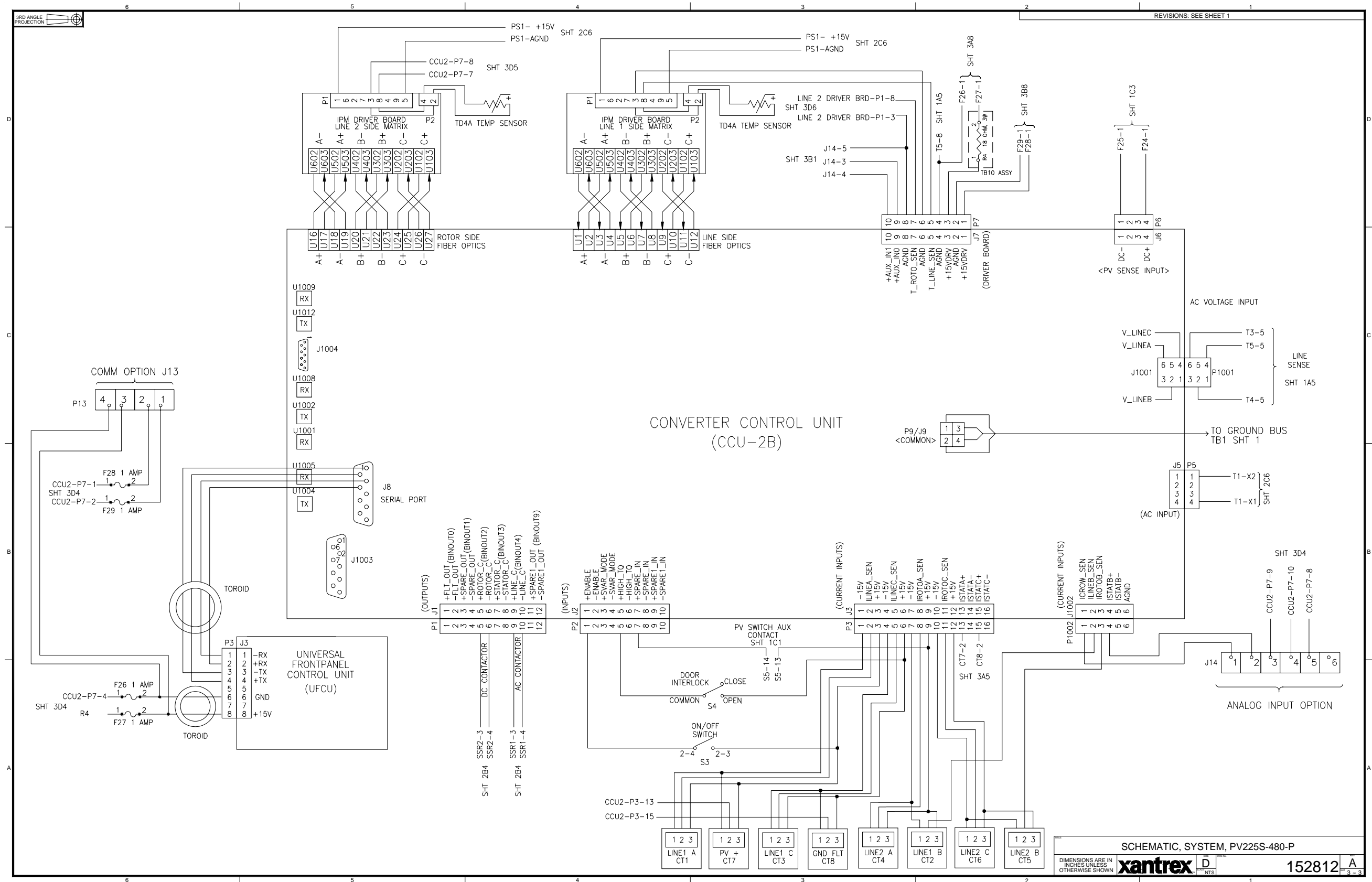

Figure A-4 PV225S Schematic for Converter Control Unit (152812 A3)

Warranty and Product Information

Xantrex Limited Warranty

PV225S GRID TIE INVERTER (PV SERIES INVERTER)

1. What does this warranty cover and how long does it last?

This Limited Warranty is provided by Xantrex Technology Inc. (“Xantrex”) and covers defects in workmanship and materials in your **PV Series Inverter**. This warranty lasts for a Warranty Period of **5 years** from the date of purchase at point of sale to you, the original end user customer.

2. What will Xantrex do?

Xantrex will, at its option, repair or replace the defective product free of charge, provided that you notify Xantrex of the product defect within the Warranty Period, and provided that Xantrex through inspection establishes the existence of such a defect and that it is covered by this Limited Warranty.

Xantrex will, at its option, use new and/or reconditioned parts in performing warranty repair and building replacement products. Xantrex reserves the right to use parts or products of original or improved design in the repair or replacement. If Xantrex repairs or replaces a product, its warranty continues for the remaining portion of the original Warranty Period or 90 days from the date of the return shipment to the customer, whichever is greater. All replaced products and all parts removed from repaired products become the property of Xantrex.

Xantrex covers both parts and labor necessary to repair the product, and return shipment to the customer via a Xantrex-selected non-expedited surface freight within the contiguous United States and Canada. Alaska and Hawaii are excluded. Contact Xantrex Customer Service for details on freight policy for return shipments outside of the contiguous United States and Canada.

3. What does this warranty not cover?

This Limited Warranty does not cover normal wear and tear of the product or costs related to the removal, installation, or troubleshooting of the customer’s electrical systems. This warranty does not apply to and Xantrex will not be responsible for any defect in or damage to the product:

- a) if it has been misused, neglected, improperly installed, physically damaged or altered, either internally or externally, or damaged from improper use or use in an unsuitable environment;
- b) if it has been subjected to fire, water, generalized corrosion, biological infestations, or input voltage that creates operating conditions beyond the maximum or minimum limits listed in the Xantrex product specifications including high input voltage from generators and lightning strikes;
- c) if repairs have been done to it other than by Xantrex or its authorized service centers (hereafter “ASCs”);
- d) if it is used as a component part of a product expressly warranted by another manufacturer; and
- e) if its original identification (trade-mark, serial number) markings have been defaced, altered, or removed.

4. Product Disclaimer

THIS LIMITED WARRANTY IS THE SOLE AND EXCLUSIVE WARRANTY PROVIDED BY XANTREX IN CONNECTION WITH YOUR XANTREX PRODUCT AND IS, WHERE PERMITTED BY LAW, IN LIEU OF ALL OTHER WARRANTIES, CONDITIONS, GUARANTEES, REPRESENTATIONS, OBLIGATIONS AND LIABILITIES, EXPRESS OR IMPLIED, STATUTORY OR OTHERWISE IN CONNECTION WITH THE PRODUCT, HOWEVER ARISING (WHETHER BY CONTRACT, TORT, NEGLIGENCE, PRINCIPLES OF MANUFACTURER'S LIABILITY, OPERATION OF LAW, CONDUCT, STATEMENT OR OTHERWISE), INCLUDING WITHOUT RESTRICTION ANY IMPLIED WARRANTY OR CONDITION OF QUALITY, MERCHANTABILITY OR FITNESS FOR A PARTICULAR PURPOSE. ANY IMPLIED WARRANTY OF MERCHANTABILITY OR FITNESS FOR A PARTICULAR PURPOSE TO THE EXTENT REQUIRED UNDER APPLICABLE LAW TO APPLY TO THE PRODUCT SHALL BE LIMITED IN DURATION TO THE PERIOD STIPULATED UNDER THIS LIMITED WARRANTY.

IN NO EVENT WILL XANTREX BE LIABLE FOR ANY SPECIAL, INDIRECT, INCIDENTAL OR CONSEQUENTIAL DAMAGES, LOSSES, COSTS OR EXPENSES HOWEVER ARISING WHETHER IN CONTRACT OR TORT INCLUDING WITHOUT RESTRICTION ANY ECONOMIC LOSSES OF ANY KIND, ANY LOSS OR DAMAGE TO PROPERTY, ANY PERSONAL INJURY, ANY DAMAGE OR INJURY ARISING FROM OR AS A RESULT OF MISUSE OR ABUSE, OR THE INCORRECT INSTALLATION, INTEGRATION OR OPERATION OF THE PRODUCT.

5. Limitations to Product Disclaimer

If this product is a consumer product, federal law does not allow an exclusion of implied warranties. To the extent you are entitled to implied warranties under federal law, to the extent permitted by applicable law they are limited to the duration of this Limited Warranty. Some states and provinces do not allow limitations or exclusions on implied warranties or on the duration of an implied warranty or on the limitation or exclusion of incidental or consequential damages, so the above limitation(s) or exclusion(s) may not apply to you. This Limited Warranty gives you specific legal rights. You may have other rights which may vary from state to state or province to province.

6. Information Disclaimer

WITHOUT LIMITING THE GENERALITY OF THE FOREGOING, UNLESS SPECIFICALLY AGREED TO BY IT IN WRITING, XANTREX

- (a) MAKES NO WARRANTY AS TO THE ACCURACY, SUFFICIENCY OR SUITABILITY OF ANY TECHNICAL OR OTHER INFORMATION PROVIDED IN MANUALS OR OTHER DOCUMENTATION PROVIDED BY IT IN CONNECTION WITH THE PRODUCT; AND
- (b) ASSUMES NO RESPONSIBILITY OR LIABILITY FOR LOSSES, DAMAGES, COSTS OR EXPENSES, WHETHER SPECIAL, DIRECT, INDIRECT, CONSEQUENTIAL OR INCIDENTAL, WHICH MIGHT ARISE OUT OF THE USE OF SUCH INFORMATION.

THE USE OF ANY SUCH INFORMATION WILL BE ENTIRELY AT THE USER'S RISK.

7. WARNING: LIMITATIONS ON USE

Please refer to your product user manual for limitations on uses of the product. Specifically, please note that the PV Series Inverter is not intended for use in connection with life support systems and Xantrex makes no warranty or representation in connection with any use of the product for such purposes.

Xantrex Technology Inc.
161-G South Vasco Road
Livermore, CA 94551
USA

PRODUCT REGISTRATION

To ensure the fastest possible service, please ensure your system information submitted to Xantrex. Please fill the required information in and send a copy of this page to Xantrex Technology Inc. along with a copy of the GUI Commissioning File.

Fax number: 925 455 0382

Mail to: **Xantrex Technology Inc.**
161-G South Vasco Road
Livermore, CA 94551
Attention: Customer Service
USA

Customer Company Name: _____

Project Name: _____

System Location Information:

Street _____

City _____

State / Zip Code _____

Xantrex Inverter Model: _____

Serial Number of Inverter: _____

Serial Number of Isolation Transformer: _____

Name of Distributor (if applicable): _____

Xantrex Authorized Signature

Date:

Customer Authorized Signature

Date:

Note: Please email the PV225S Commissioning Report File to: pvcommissioningreport@xantrex.com.

Index

A

- AC Interface Enclosure 1–8
- Accumulated Values 1–18
- Anti-Island Protection 1–5
- Auto-restart Feature 2–23
- Autorun 2–26

C

- Clearing Faults Manually 4–3
- Command Prompt 2–27
- Commissioning 3–2
- Communication Enclosure 1–9
- Communications 2–25
- Configurable Parameters 1–18
- Controls 1–10
- Converter Control Unit (CCU2) 1–7

D

- Data Log Acquisition 1–18
- Data Logging 1–13
- DC Interface Enclosure 1–8
- Direct Connection 2–32
- Disconnect Switches 1–12

E

- EMI output filter 1–2
- enclosures 1–6

F

- Fault Code Descriptions 4–4
- Fault Log Acquisition 1–18
- Fault Reporting and Logging 1–13
- Faults 2–2
- Faults and Fault Codes 4–2

G

- General Troubleshooting 4–2
- Graphic Data Analysis 1–18
- grid-connected photovoltaic arrays 1–2
- GUI Help 2–37
- GUI Software
 - Starting the Software Setup Program 2–26
 - System Requirements 2–26

I

- Inductor Enclosure 1–7
- Installation 2–28
- integrated controller 1–2
- Internal Metrics 1–18
- Isolation Procedure 5–2

L

- Lockout and Tag 5–3

M

- Main Enclosure Door Interlock Switch 1–10
- Main Inverter Enclosure 1–7
- Maintenance Safety 5–2

O

- On/Off Switch 1–11
- Operating States 2–4
 - Fault 2–5
 - Manual Current 2–5
 - Matrix Test 2–5
 - Power Tracking 2–4
 - Shutdown 2–5
 - Transition 2–4
- Operation Features 1–2
 - Automatic Sleep Test 2–5
 - DC Overvoltage Detection 1–5
 - Fixed Unity Power Factor Operation 1–2
 - Peak Power Tracking 1–3
 - Utility Voltage/Frequency Fault Automatic Reset 1–4
- Operational Safety Procedures 5–2
- Operational Values 1–18
- Operator Interface 2–6
 - Automatic State Transitions 2–22
 - Changing Write Parameter Values 2–16
 - Commanding Goal State Changes 2–20
 - Keypad Operation 2–6
 - Manual State Transitions 2–22
 - Setting the Date and Time 2–21

P

- Period Maintenance
 - Monthly 5–6
 - Six month intervals 5–7

Index

Power Distribution Panel 1–7
Power Electronics Matrix 1–7
PV Ground Fault Detection 1–5

R

Remote Monitor and Control Features 1–18
Remote/LAN Connection 2–31
Running the GUI 2–31

S

Self-protection features 1–2
Shutdown 2–24
Specifications A–2
 Electrical A–3
 Environmental A–2
 Over Voltage, Under Voltage and Frequency Ranges
 A–3
Startup 2–24
System Operation 2–2

T

Three-phase power conversion system 1–2
Torque and Wire Gauge Specifications A–4
Transformer Enclosure 1–8

Xantrex Technology Inc.

1 800 670 0707 Tel toll free NA
1 360 925 5097 Tel direct
1 800 994 7828 Fax toll free NA
1 360 925 5143 Fax direct
customerservice@xantrex.com
www.xantrex.com